

MECHANIKA ANALITYCZNA

Błędy modelowania

LECH MURAWSKI

l.murawski@wm.umg.edu.pl

pok. A213

Benchmark

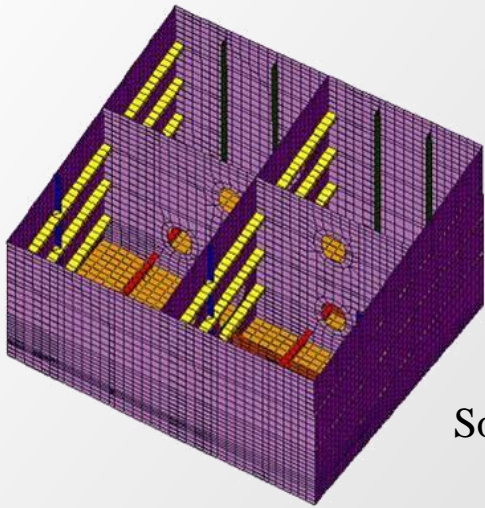

Source: ISSC

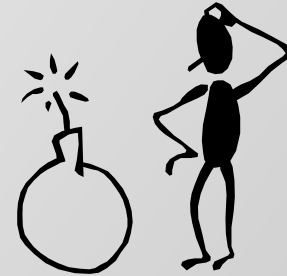

Wina obliczeń?

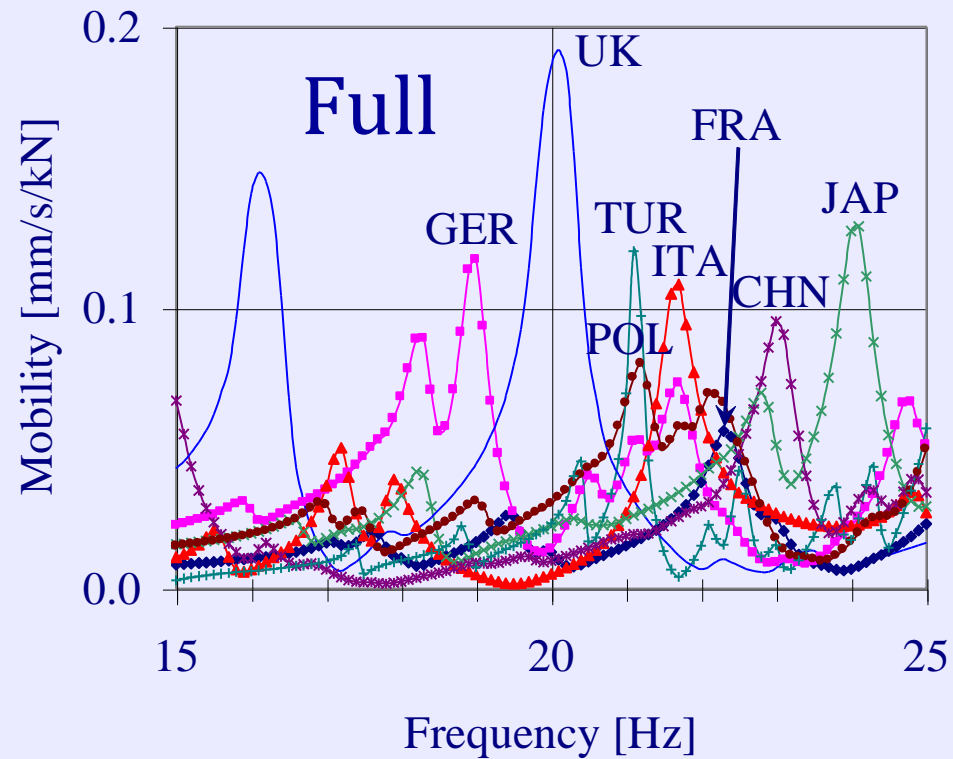
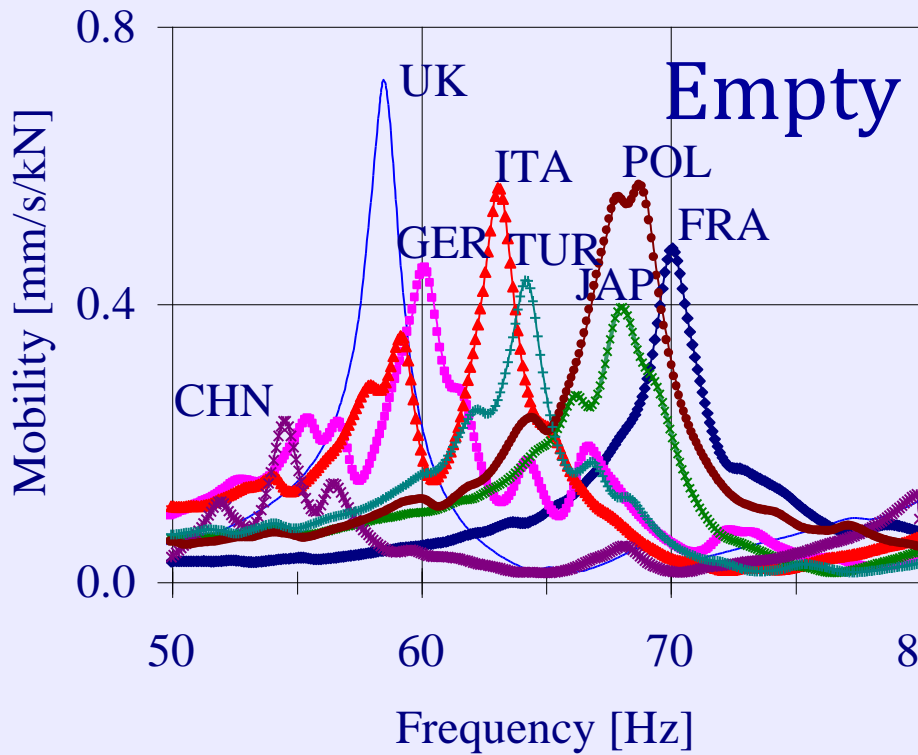

Przykład Belka z uszkodzeniami

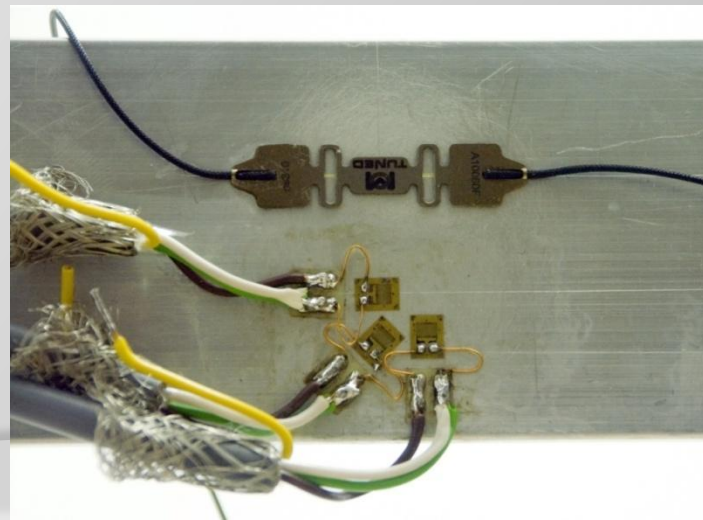
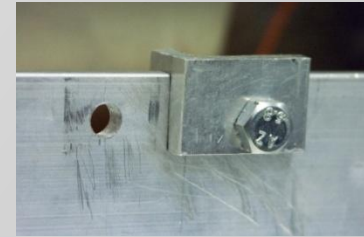
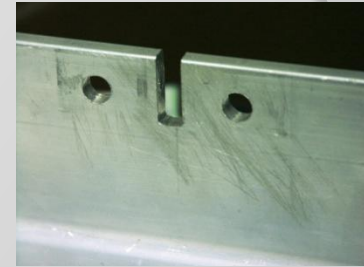

Jak liczyć tak prostą belkę?



- **Model 1:** element belkowy **Bar2**, d.o.f. 600
- **Model 2a:** płyta mocująca – elementy trójwymiarowe **Hex8**, belka - **Bar2**, d.o.f. 30366
- **Model 2b** = **2a** + offset
- **Model 2c:** płyta mocująca – elementy trójwymiarowe **Hex8**, belka – elementy powłokowe **Quad4**, d.o.f. 27966
- **Model 2c_m** = **2c** zagęszczony, d.o.f. 67638
- **Model 2d** = **2c** macierz mas rozproszona (coupled-lumped)
- **Model 3a** cały model: elementy trójwymiarowe **Hex8**, liczba stopni swobody 26664
- **Model 3a_m** = **3a** zagęszczony, d.o.f. 107427
- **Model 3b:** = **3a**, aluminium **6061-T6**, d.o.f. 26664
- **Model 3c:** = **3a**, macierz mas rozproszona, d.o.f. 26664
- **Model 3d** cały model: elementy trójwymiarowe **Hex20**, liczba stopni swobody 13803
- **Model 3d_m** = **3d** zagęszczony, d.o.f. 47640
- **Model 3e** = **3a** rozrzedzony (jeden elem. na grubość), liczba stopni swobody 15120
- **Model 2cU** = **2c** belka z uszkodzeniem

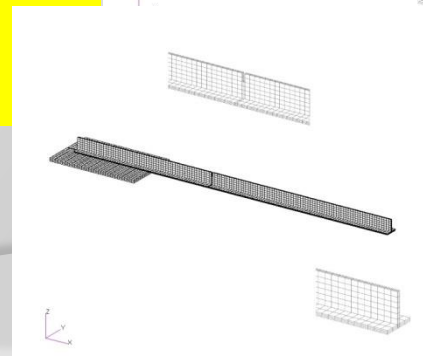
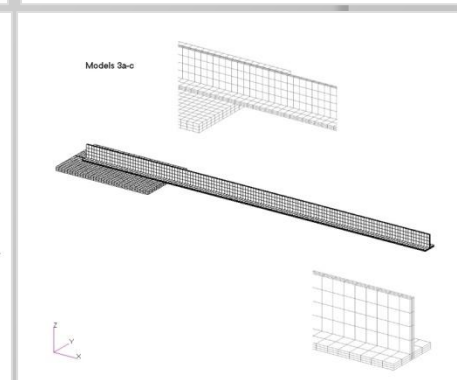
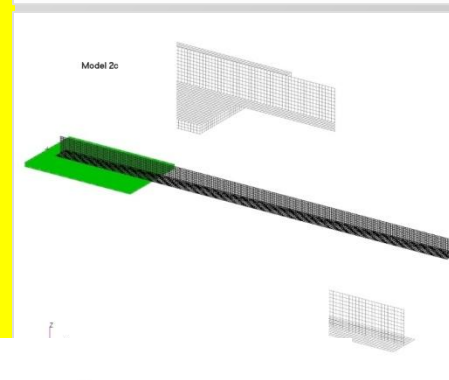
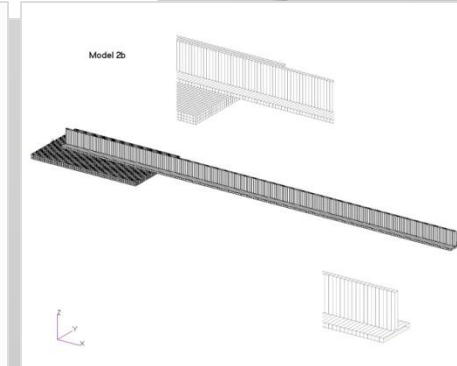
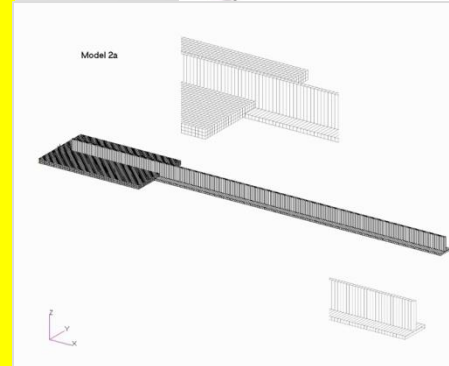
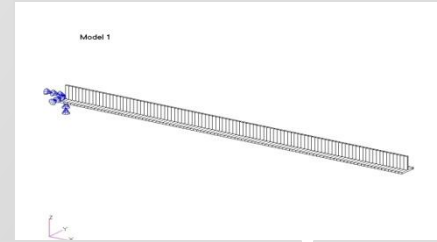

Wyniki obliczeń belki

| Postać \ Model | Częstotliwości drgań własnych [Hz] | | | | | | | | | |
|-------------------|------------------------------------|-----------|-----------|-----------|-----------|-----------|-----------|-----------|-----------------------|-----------|
| | 1 | 2a | 2b | 2c | 2d | 3a | 3b | 3c | 3d_m | 3e |
| 1 | 29.159 | 29.159 | 29.159 | 27.557 | 27.558 | 28.279 | 29.429 | 28.281 | 28.223 | 28.294 |
| 2 | 42.623 | 42.621 | 42.621 | 41.445 | 41.446 | 39.808 | 41.426 | 39.81 | 39.756 | 39.836 |
| 3 | 181.13 | 181.09 | 181.09 | 112.31 | 112.89 | 119.04 | 123.88 | 122.16 | 117.52 | 118.81 |
| 4 | 261.68 | 261.53 | 261.53 | 168.64 | 168.77 | 173.98 | 181.05 | 174.58 | 173.25 | 174.04 |
| 5 | 500.21 | 499.85 | 499.85 | 254.95 | 254.97 | 245.51 | 255.49 | 245.61 | 245.11 | 245.71 |
| 6 | 710.11 | 708.93 | 708.93 | 330.59 | 331.85 | 350.9 | 365.17 | 357.81 | 346.7 | 350.48 |
| 7 | 961.26 | 959.82 | 959.82 | 433.14 | 434.51 | 452.84 | 471.25 | 459.46 | 448.42 | 452.56 |
| 8 | 1246.2 | 1200.4 | 1200.4 | 575.51 | 577.14 | 613.05 | 637.98 | 622.45 | 605.75 | 612.65 |
| 9 | 1333.6 | 1329.4 | 1329.4 | 690.37 | 690.51 | 667.69 | 694.83 | 668.3 | 666.2 | 668.35 |
| 10 | 1551 | 1547.1 | 1547.1 | 740.86 | 744.15 | 766.25 | 797.4 | 783.24 | 760.2 | 764.77 |

Wyniki obliczeń belki

| | Częstotliwości drgań własnych [Hz] | | | | | |
|----------------|------------------------------------|-----------------------|-----------|-----------------------|-----------|-----------------------|
| Postać \ Model | 2c | 2c_m | 3a | 3a_m | 3d | 3d_m |
| 1 | 27.557 | 27.556 | 28.279 | 28.237 | 28.278 | 28.223 |
| 2 | 41.445 | 41.455 | 39.808 | 39.759 | 39.837 | 39.756 |
| 3 | 112.31 | 111.91 | 119.04 | 119.8 | 108.16 | 117.52 |
| 4 | 168.64 | 168.53 | 173.98 | 173.81 | 171.83 | 173.25 |
| 5 | 254.95 | 254.95 | 245.51 | 245.19 | 245.41 | 245.11 |
| 6 | 330.59 | 329.57 | 350.9 | 351.97 | 324.39 | 346.7 |
| 7 | 433.14 | 432.15 | 452.84 | 453.68 | 428.84 | 448.42 |
| 8 | 575.51 | 573.83 | 613.05 | 613.2 | 576.38 | 605.75 |
| 9 | 690.37 | 690.38 | 667.69 | 666.66 | 666.37 | 666.2 |
| 10 | 740.86 | 739.7 | 766.25 | 771.51 | 714.1 | 760.2 |

Wyniki obliczeń belki

| Postać \ Model | Częstotliwości drgań własnych [Hz] | | | |
|----------------|------------------------------------|--------|--------|--------|
| | $3c_0$ | $3c$ | $2d_0$ | $2d$ |
| 1 | 28.274 | 28.281 | 27.553 | 27.558 |
| 2 | 38.396 | 39.81 | 39.975 | 41.446 |
| 3 | 121.32 | 122.16 | 112.38 | 112.89 |
| 4 | 174.53 | 174.58 | 168.82 | 168.77 |
| 5 | 244.35 | 245.61 | 253.55 | 254.97 |
| 6 | 357.76 | 357.81 | 332.64 | 331.85 |
| 7 | 458.5 | 459.46 | 434.3 | 434.51 |
| 8 | 619.94 | 622.45 | 575.64 | 577.14 |
| 9 | 647.05 | 668.3 | 668.37 | 690.51 |
| 10 | 781.1 | 783.24 | 743.36 | 744.15 |

Błędy obliczeniowe

Błędy względne modeli względem tych samych

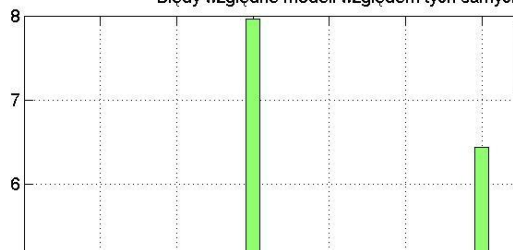

Błędy względne modeli względem modelu (Model 3a) zbudowanego z elementów Hex8

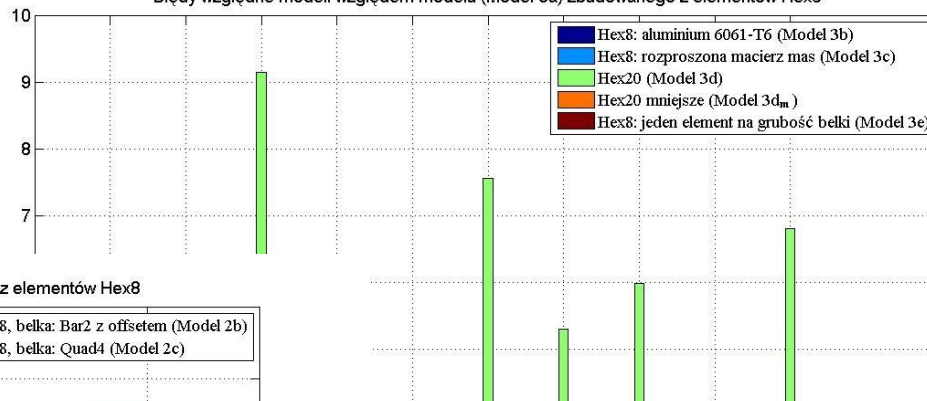

Błędy względne modeli względem modelu (Model 3a) zbudowanego z elementów Hex8

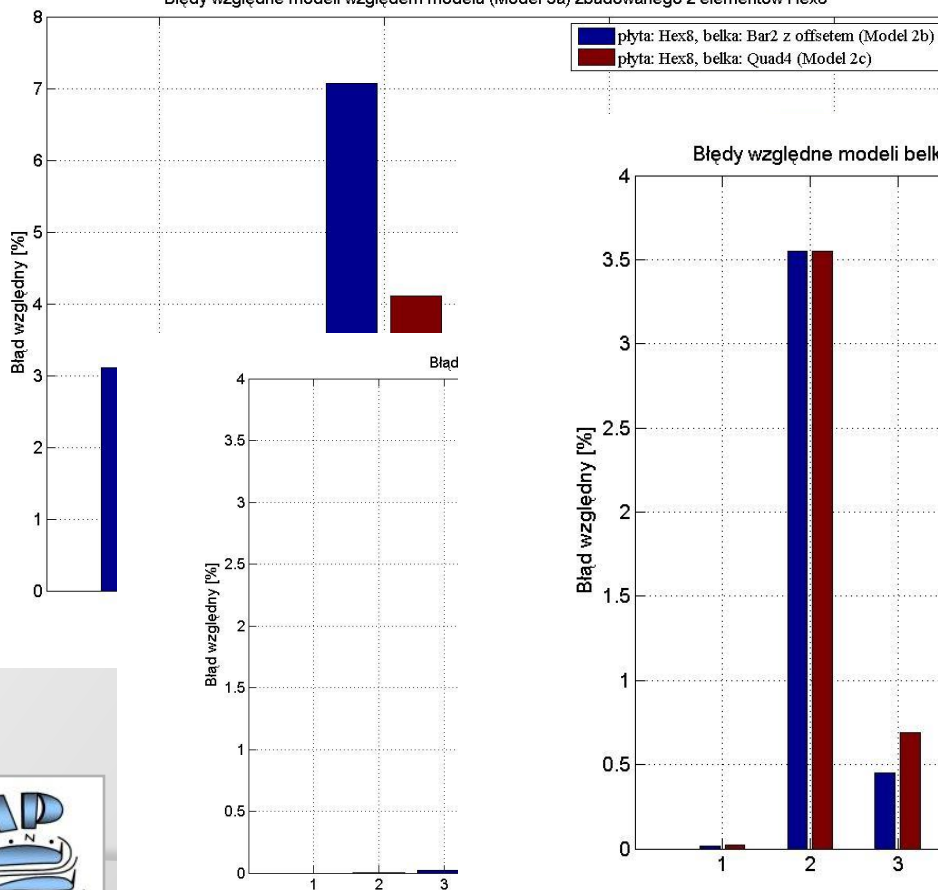

Błędy względne modeli belki ze szczeliną otwartą względem tych samych modeli dla belki nieuszkodzonej

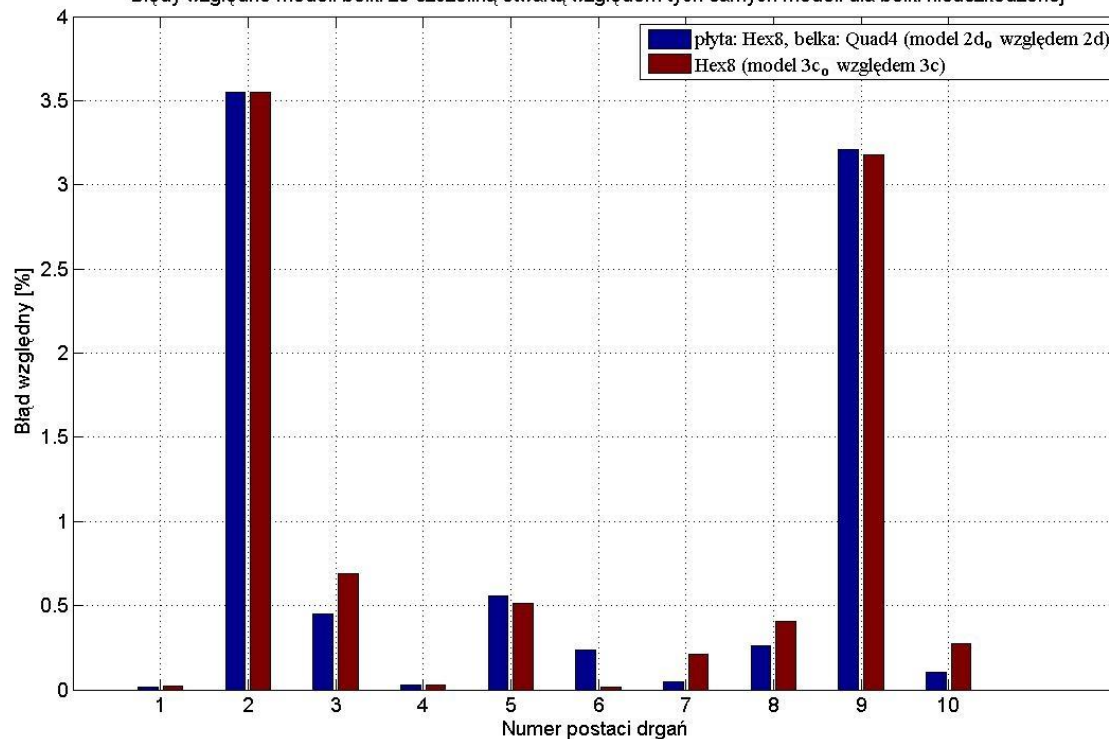

Pomiary belki

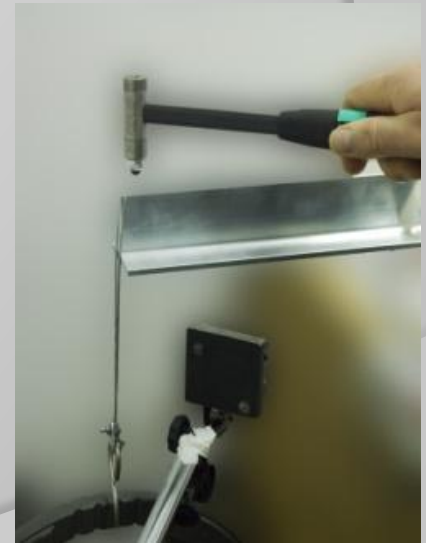
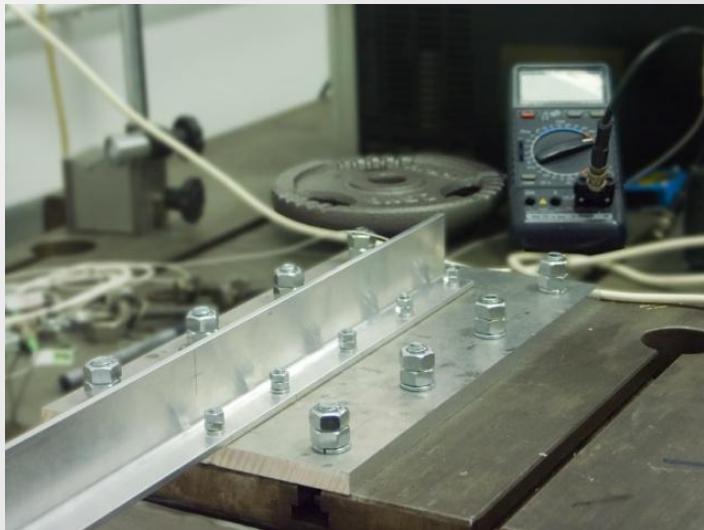
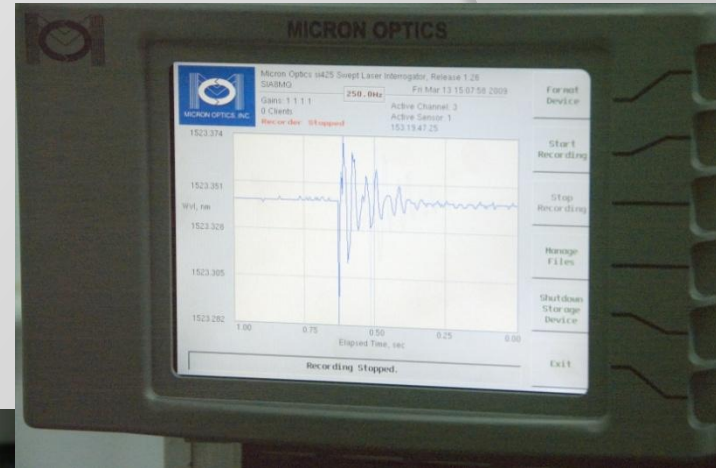
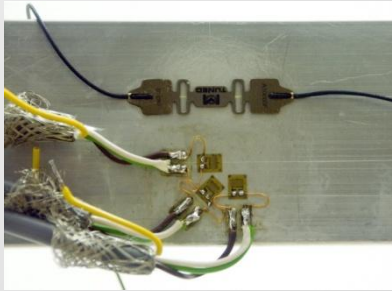
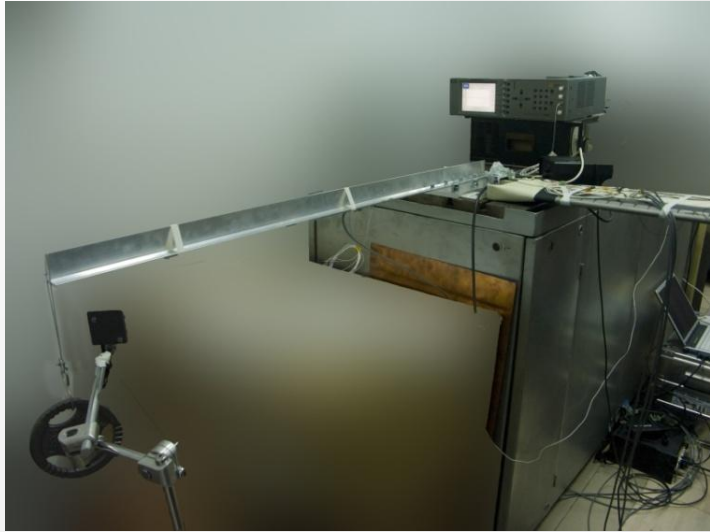

Badania laboratoryjne – wirnik helikoptera + usztywnienie konstrukcji

Badania laboratoryjne różnych typów uszkodzeń konstrukcji

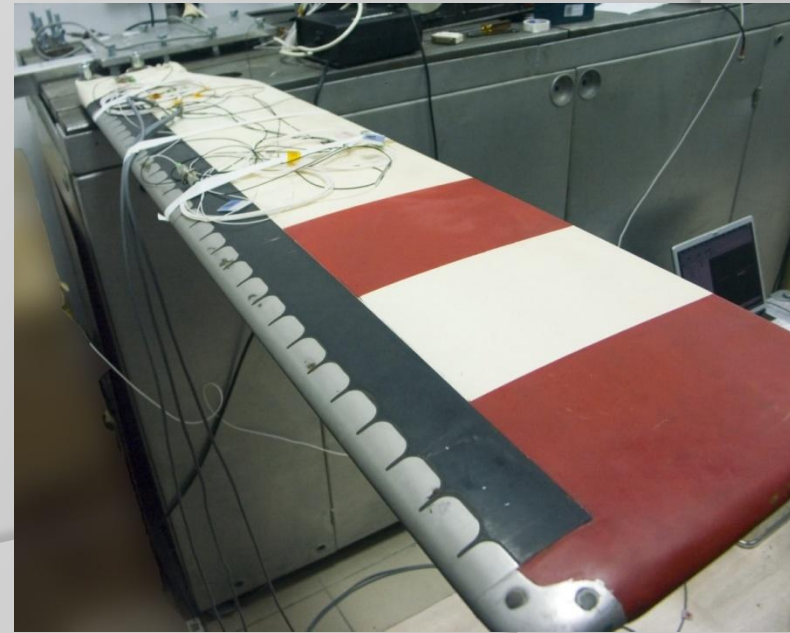
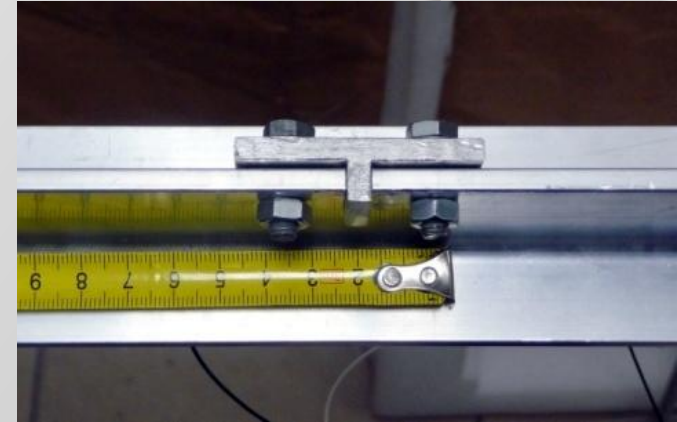
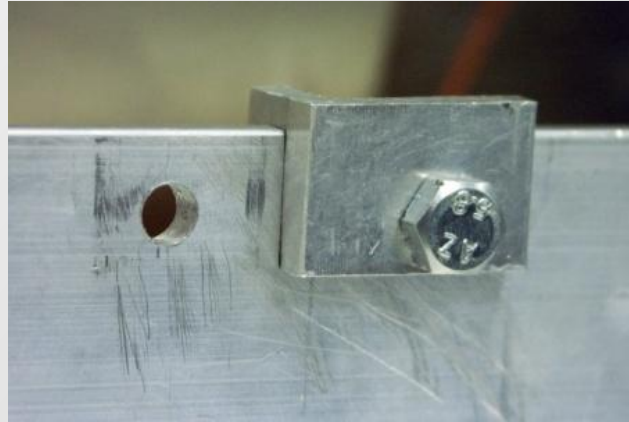

Nowe techniki pomiarowe

czujniki FBG

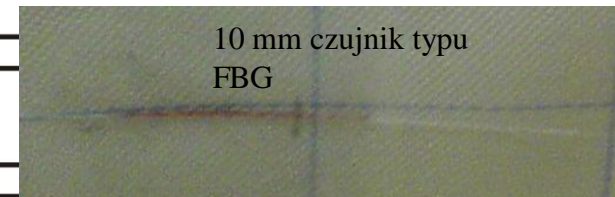
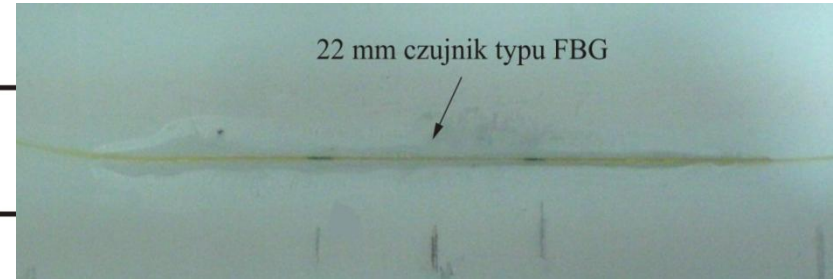

os3100 Optical Strain Gage



os4100 Temperature Compensation Sensor

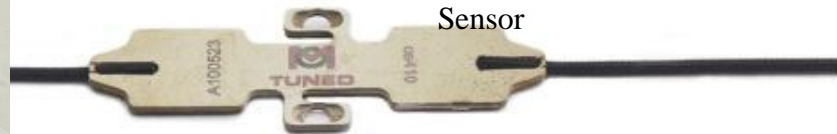

Czujnik typu FBG

FBG is made by periodically changing the refractive index in the glass core of a fibre.

$$\lambda_B = 2n_e \Lambda$$

$$\Delta\lambda_B/\lambda_B = (1 - \rho_\varepsilon) \varepsilon + (\alpha + \zeta) T$$

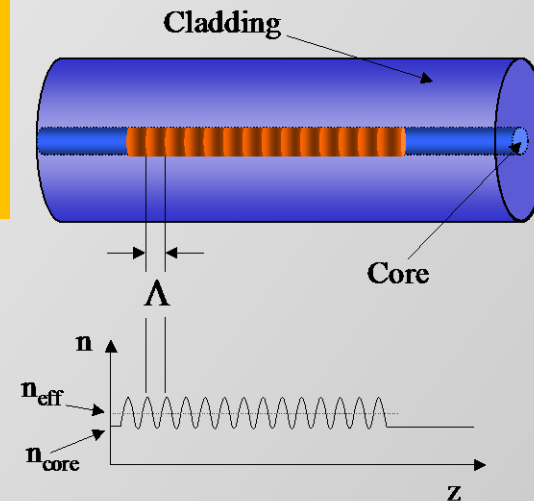

Reflected Spectrum

Incoming Spectrum

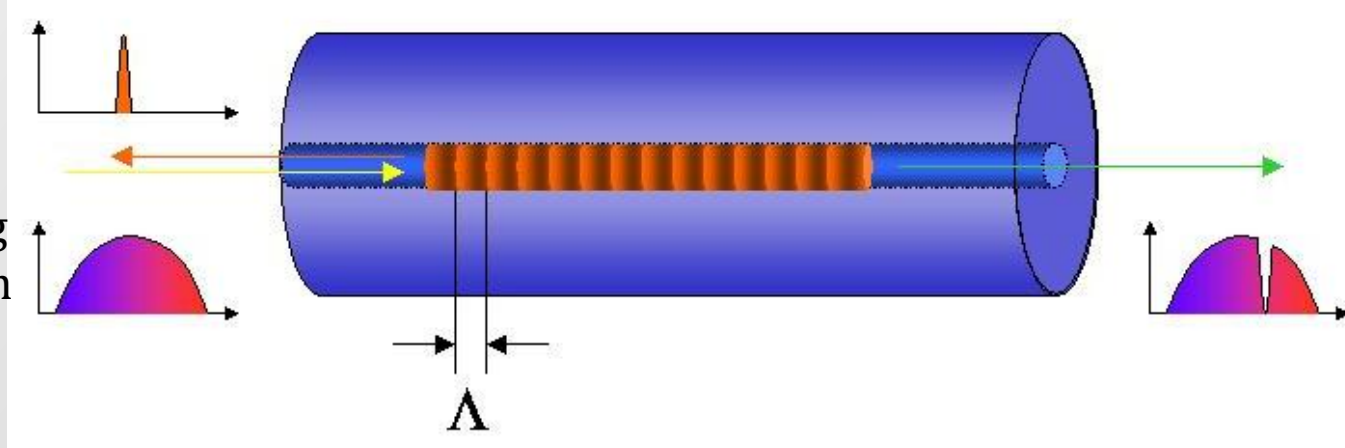

Transmitted Spectrum

Zasada działania

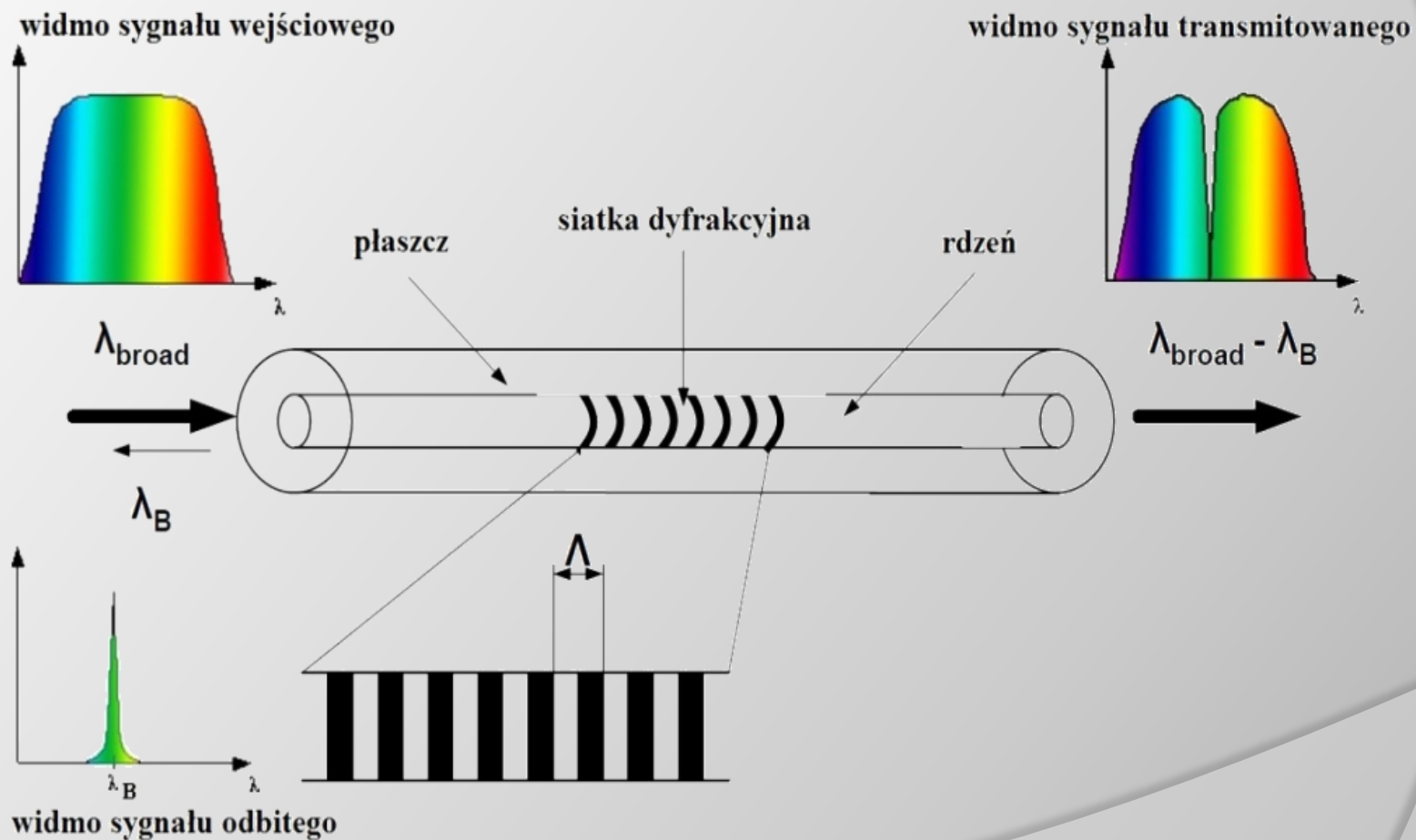

Dobór konstrukcji do analizy

HLJV Innovation

Długość całkowita:

188,70 m

Szerokość: 42 m

Wysokość konstrukcyjna

11 m

Wyporność: 22313 t



Statek do montażu elektrowni wiatrowych

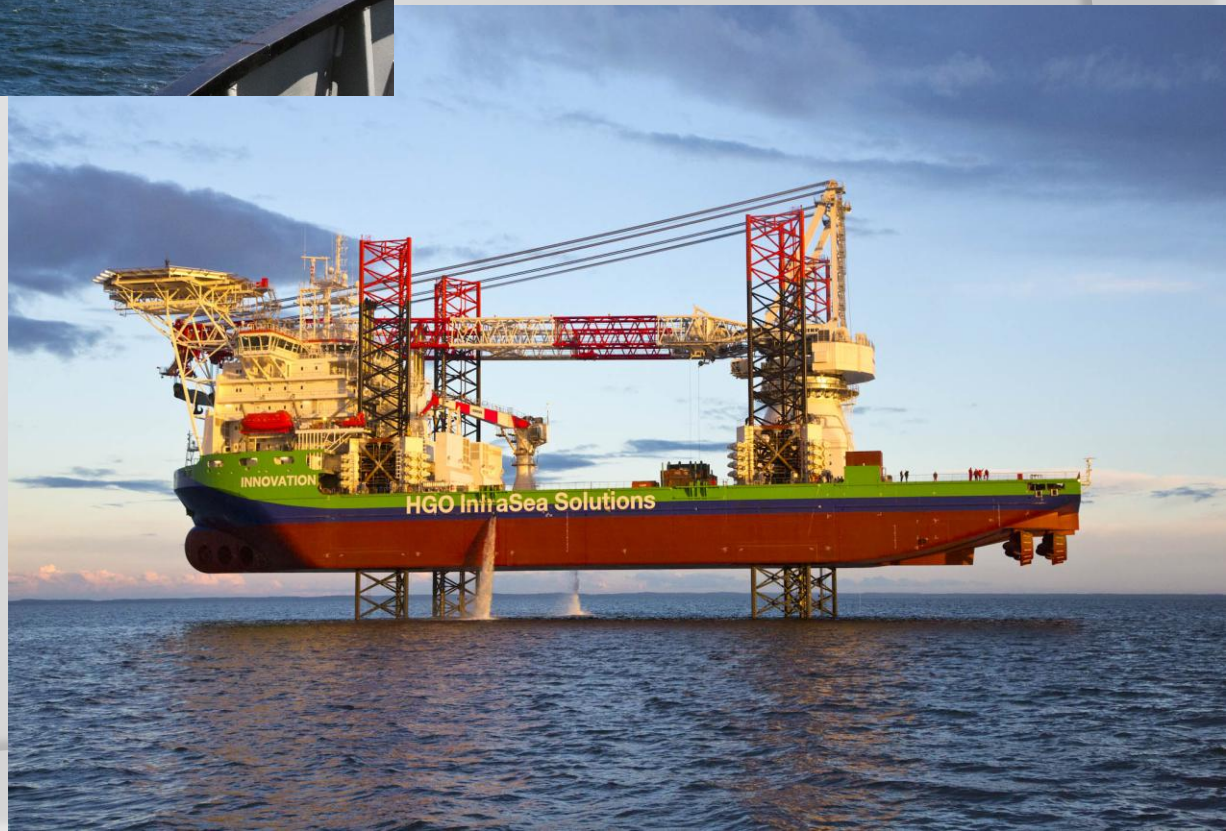

HLJV Innovation

Długość całkowita:

188,70 m

Szerokość: 42 m

Wysokość

konstrukcyjna:

11 m

Wyporność: 22313 t

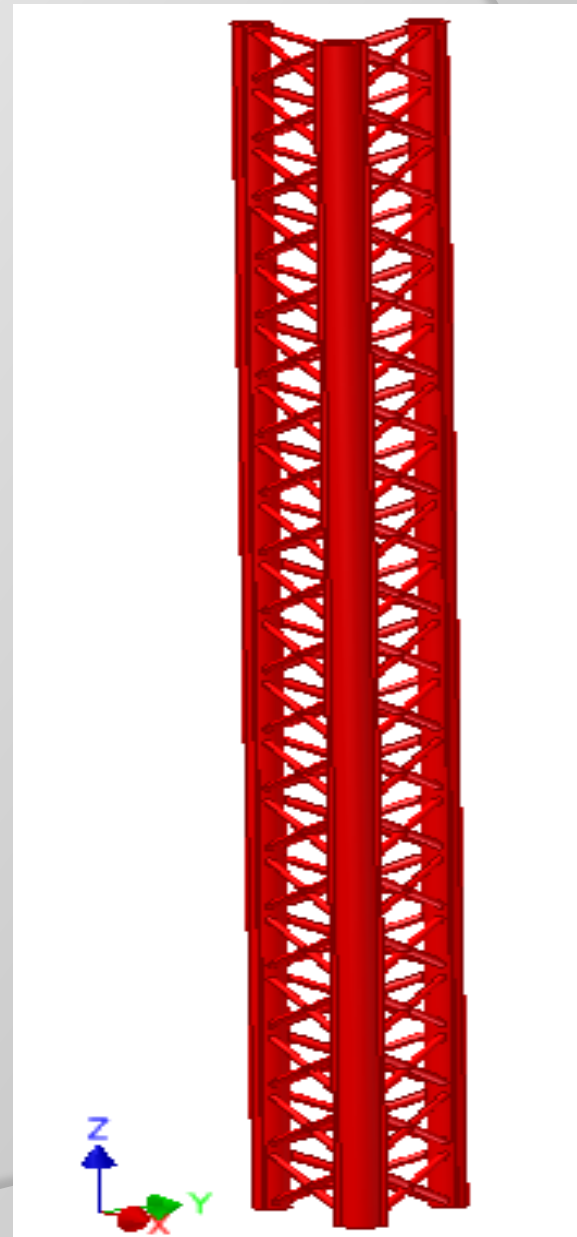
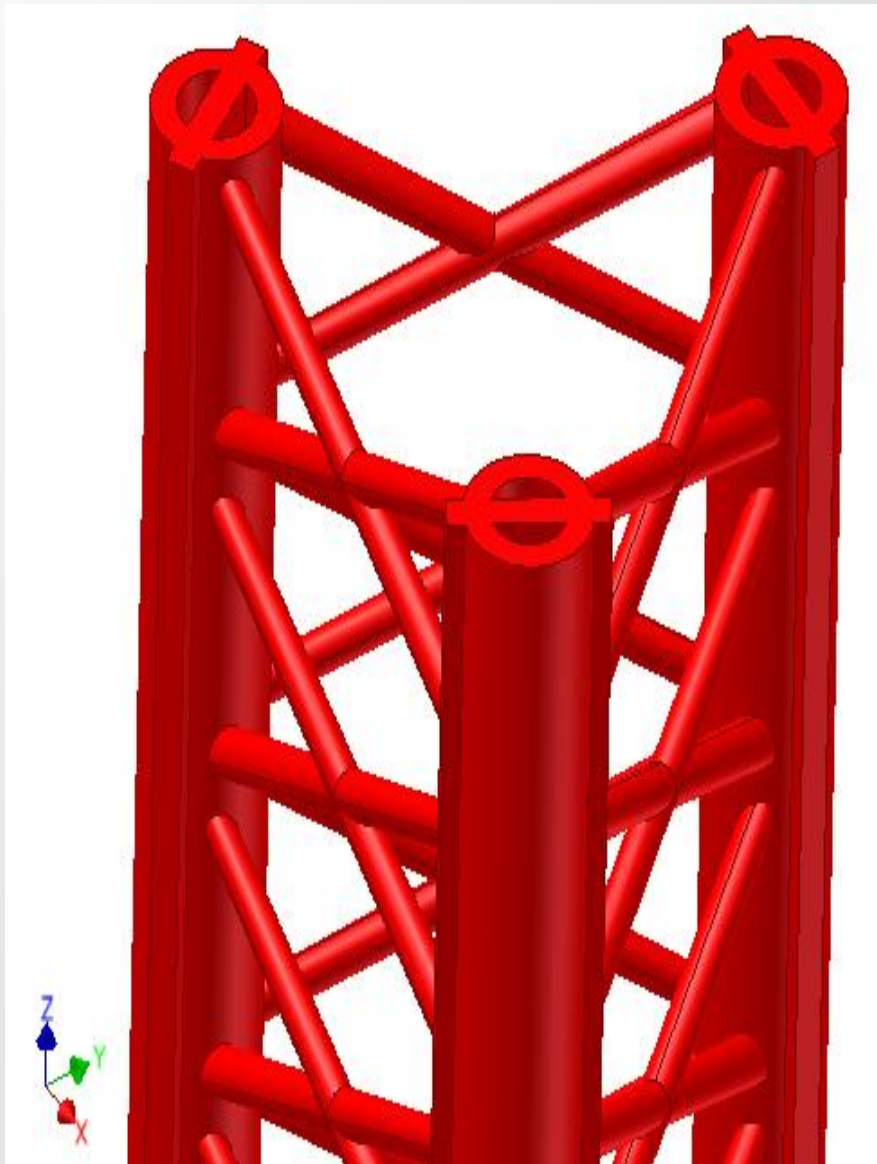

Budowa modelu w programie Patran

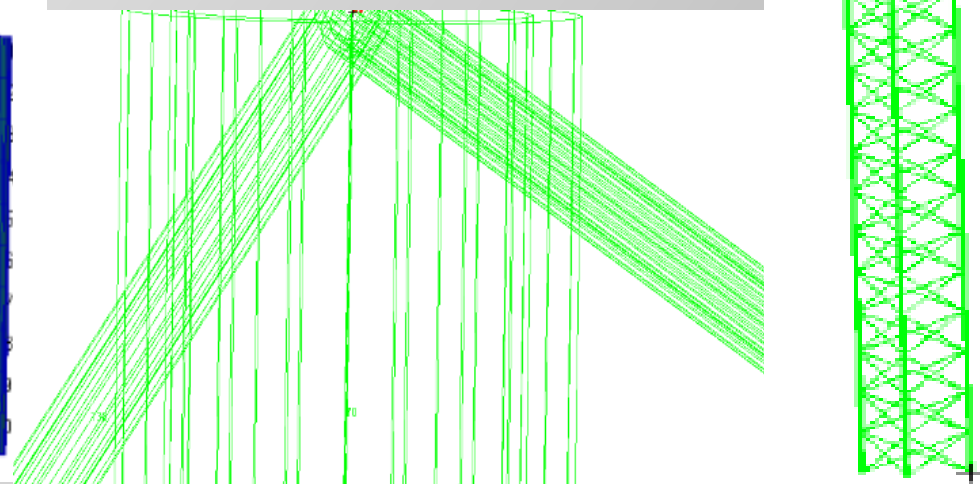
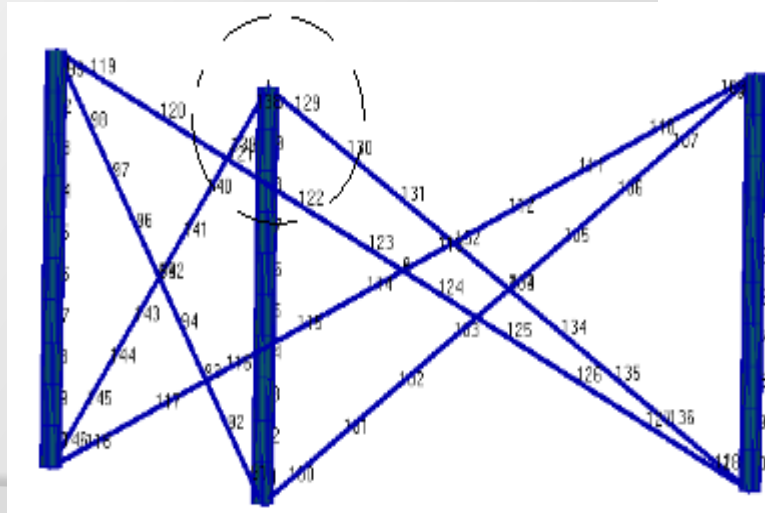
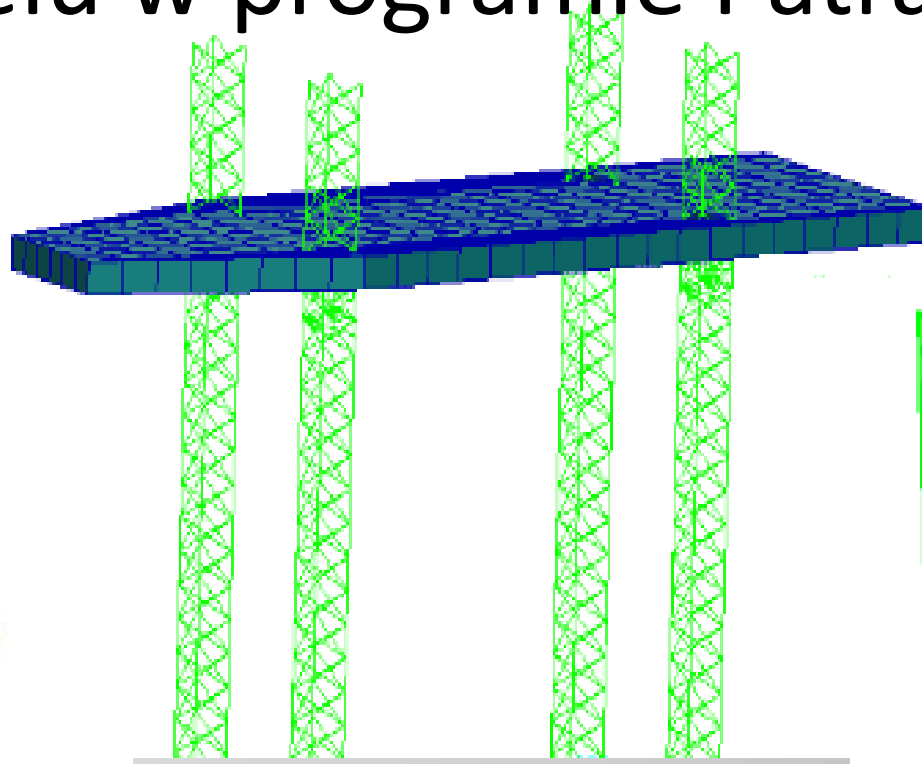
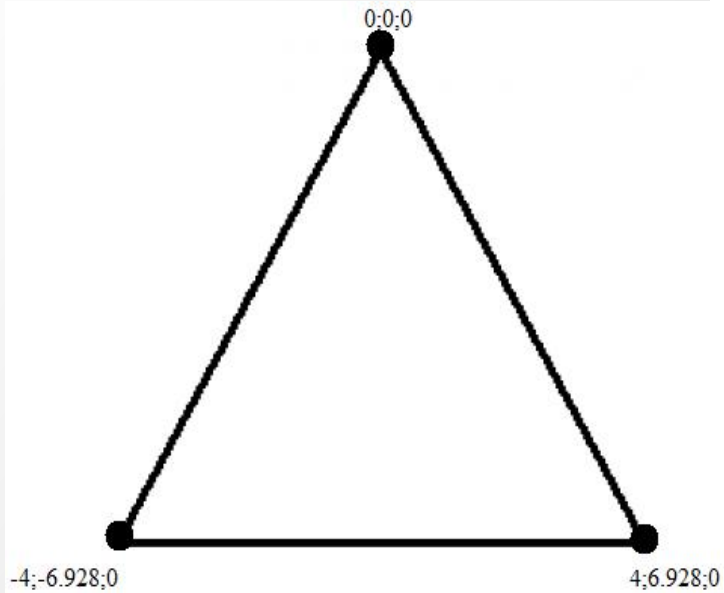

Analiza przemieszczeń

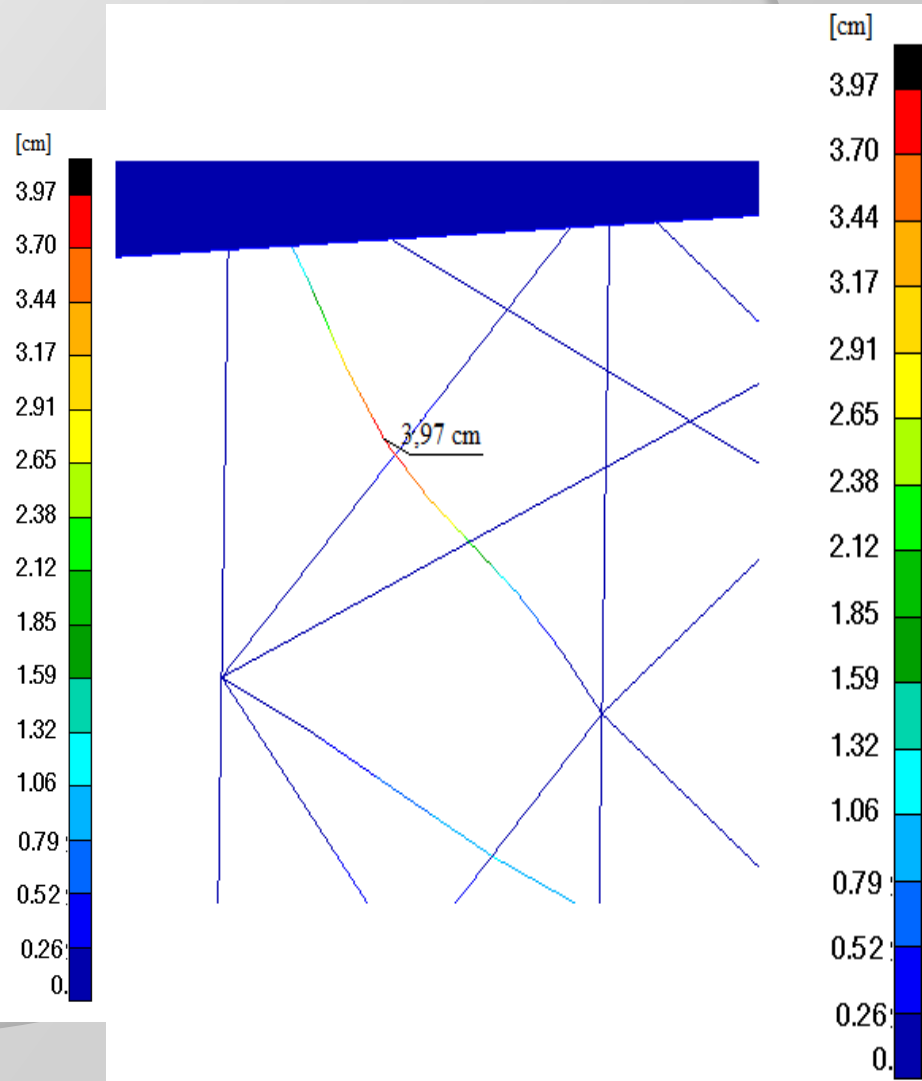
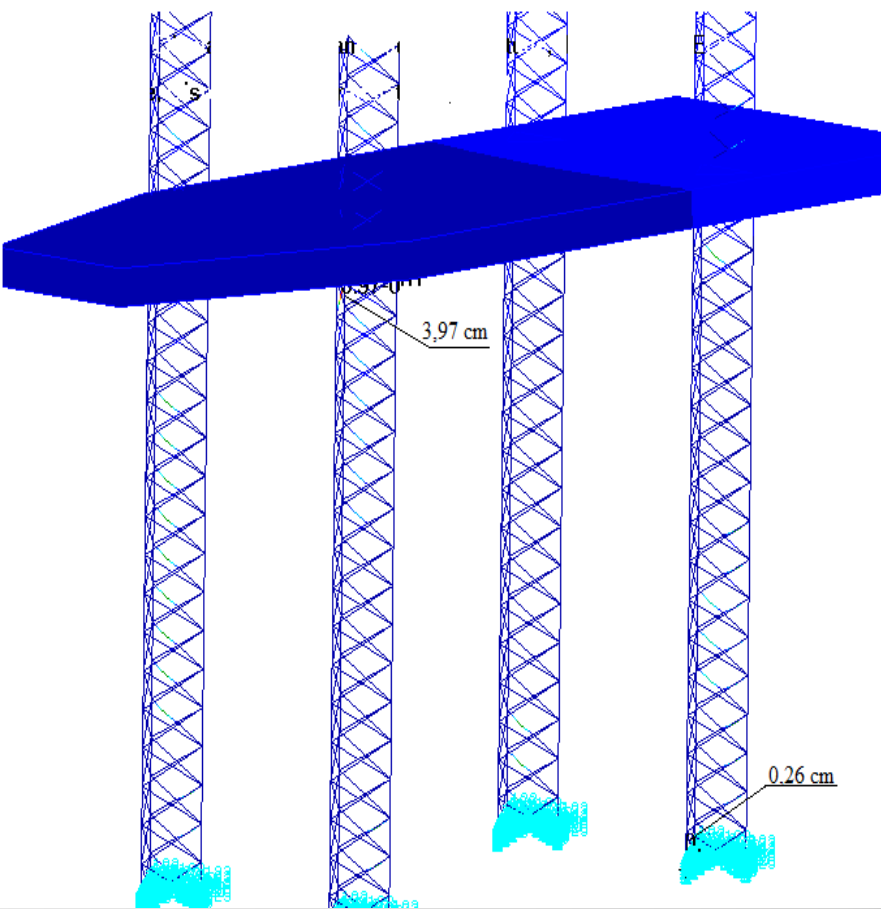

Analiza naprężeń ściskających

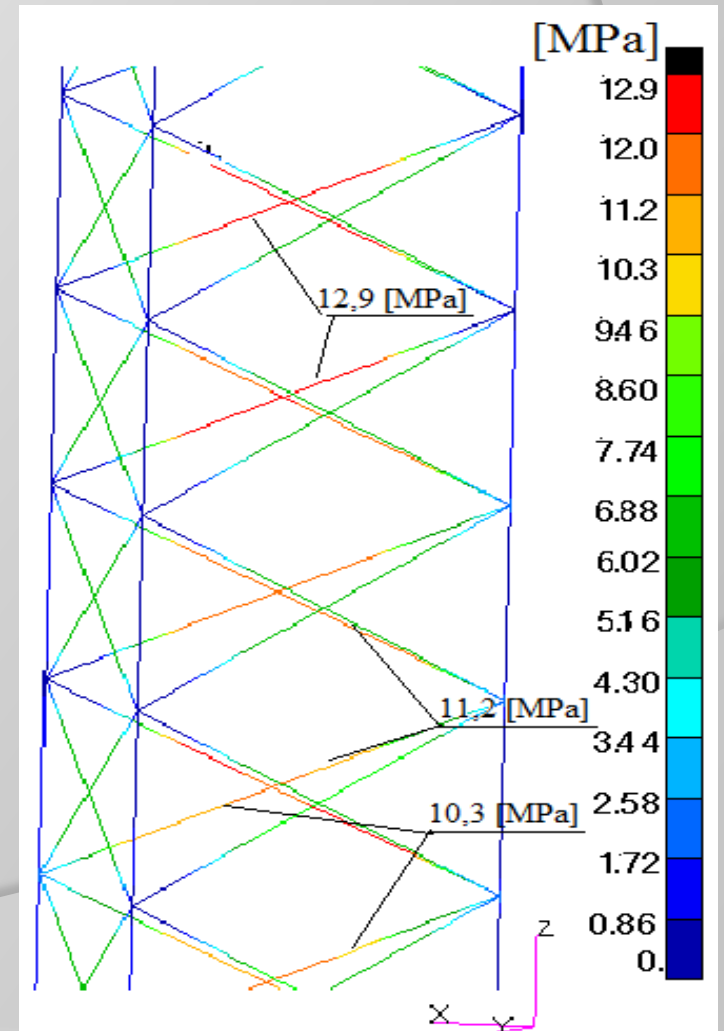
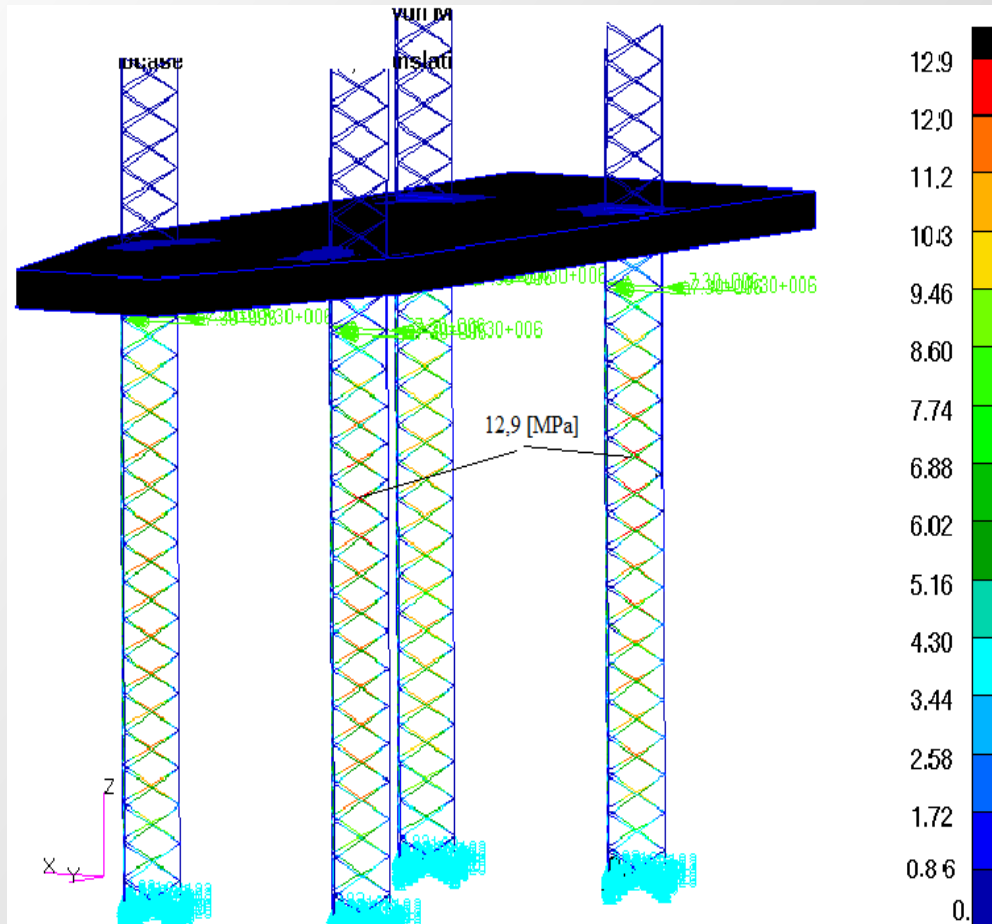

Analiza naprężeń zginających w wyniku oddziaływania siły wzdłuż osi x

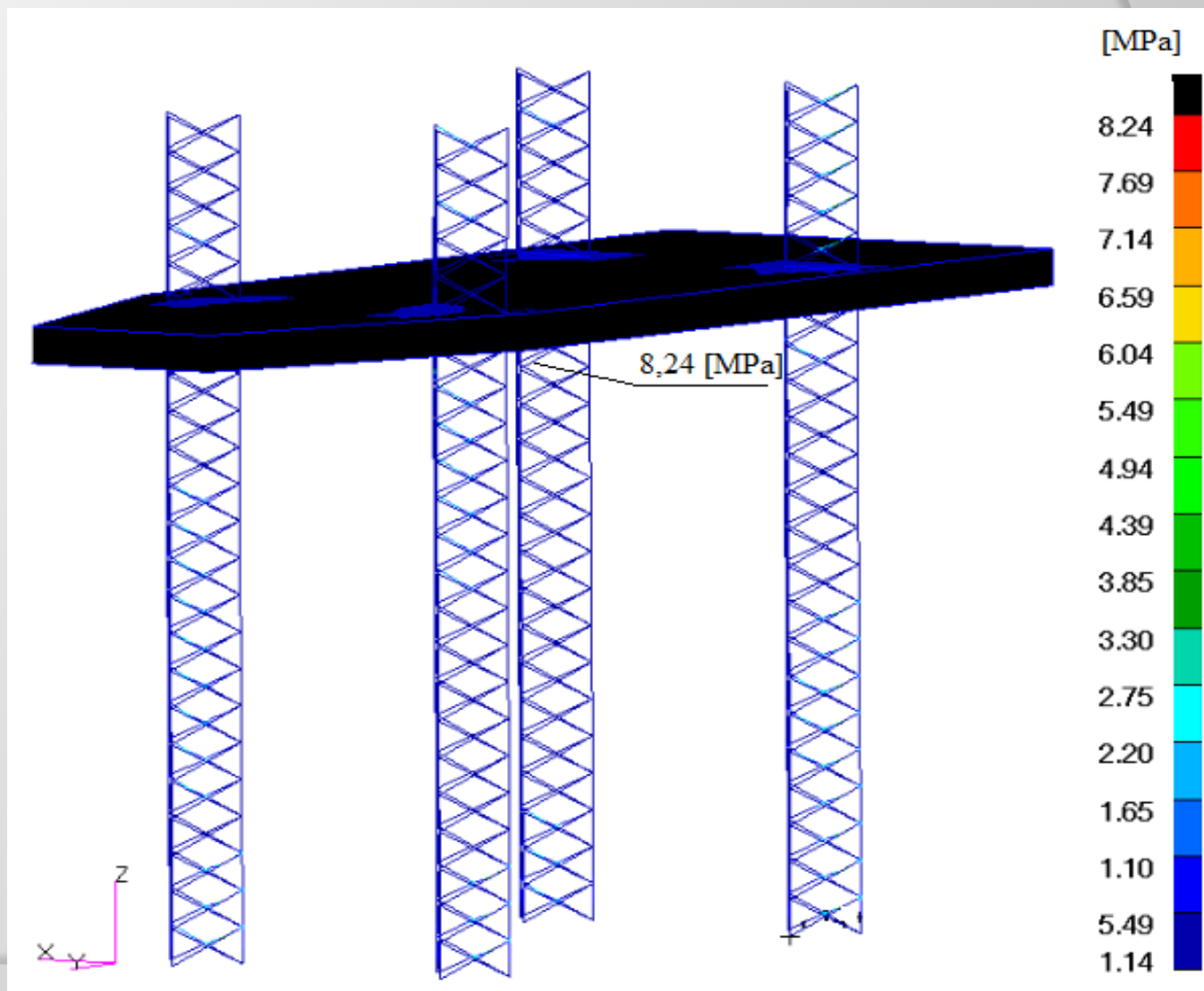

Dobór sposobu i projekt monitoringu

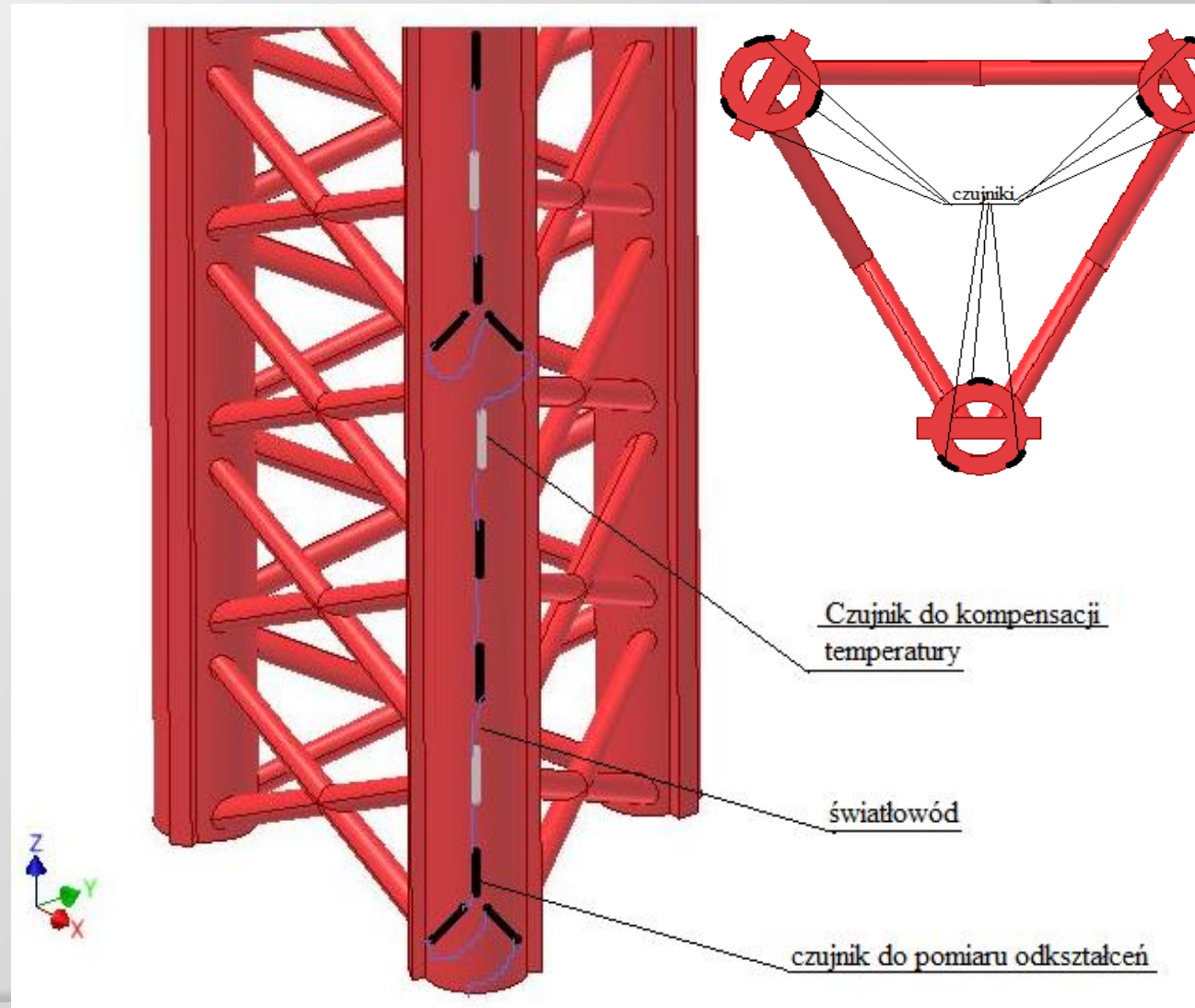
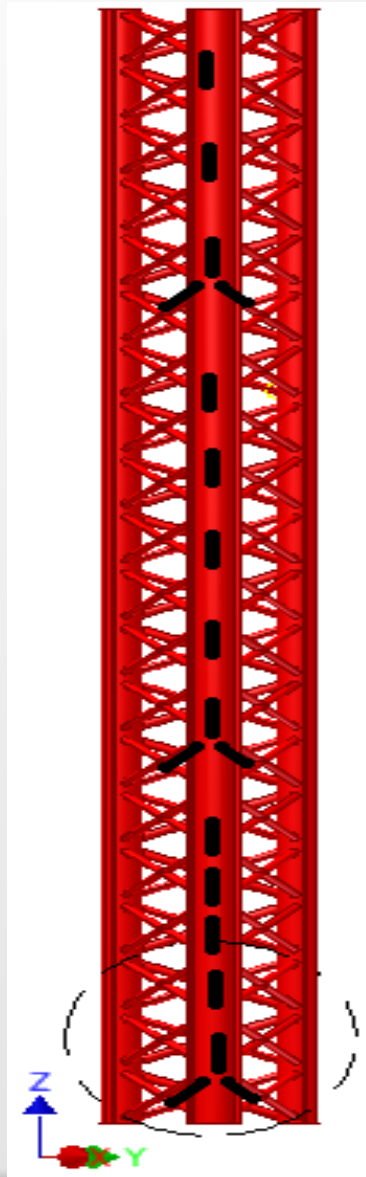

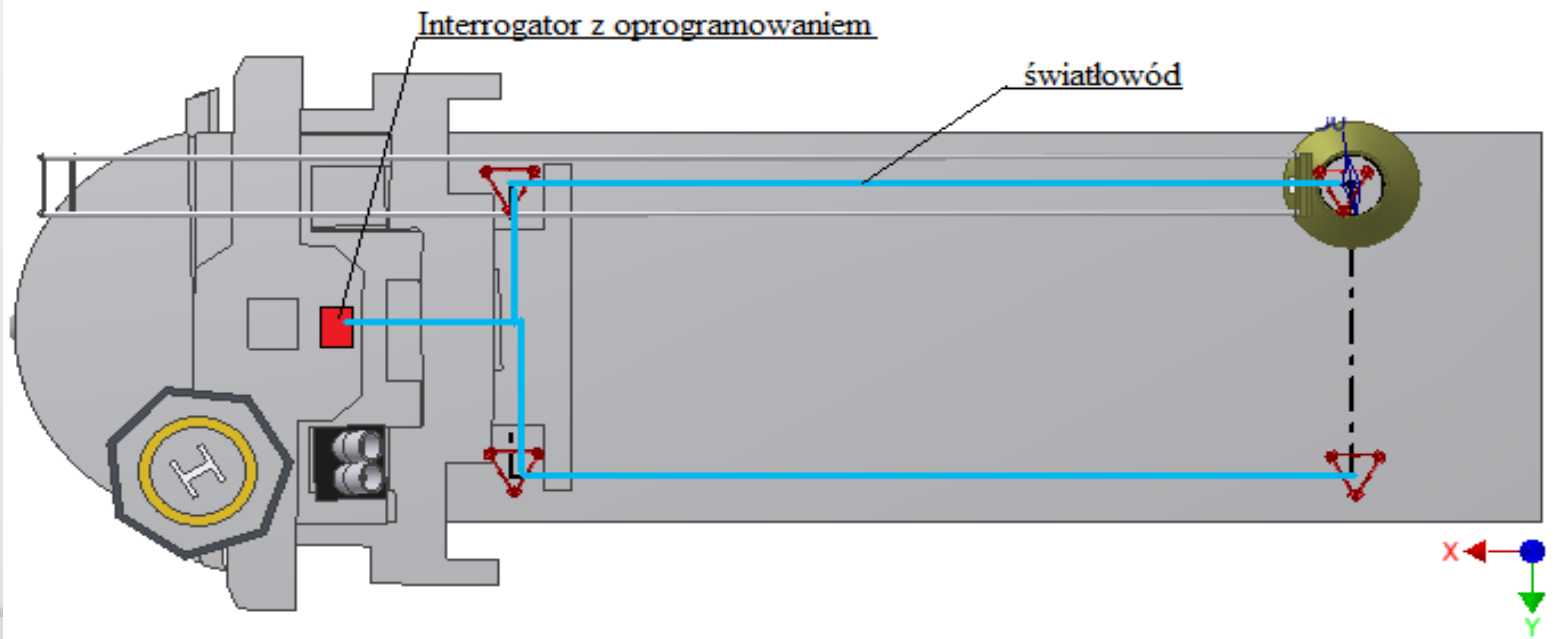
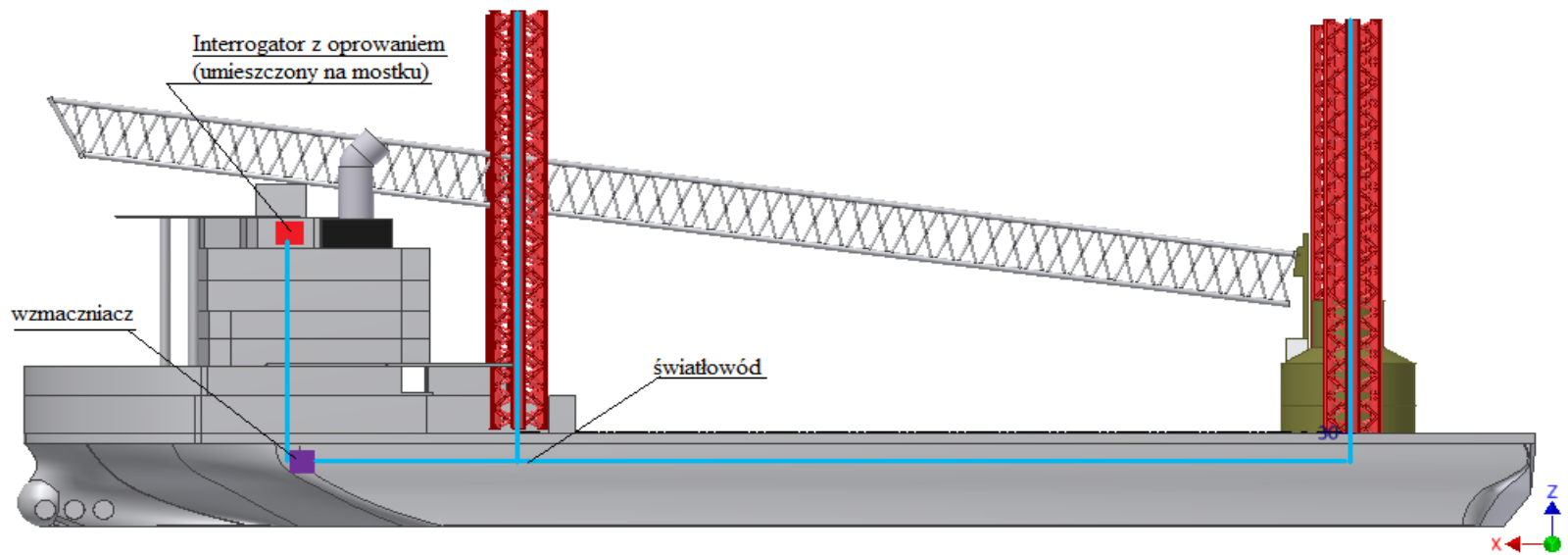

Płynięcie poziomu zerowego

Porównanie techniki tensometrycznej z światłowodową

$7E-8 \mu\text{m}/\text{m}$

$30 \mu\text{m}/\text{m}$

$4 \mu\text{m}/\text{m}$

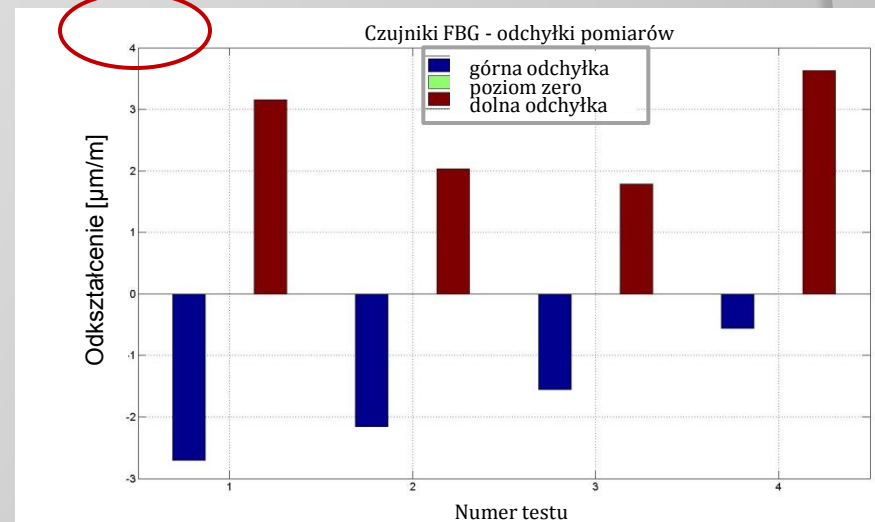
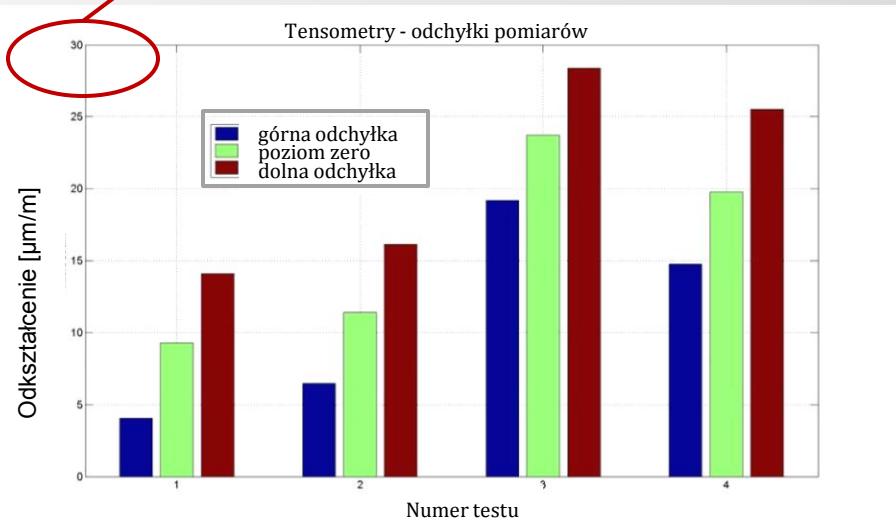
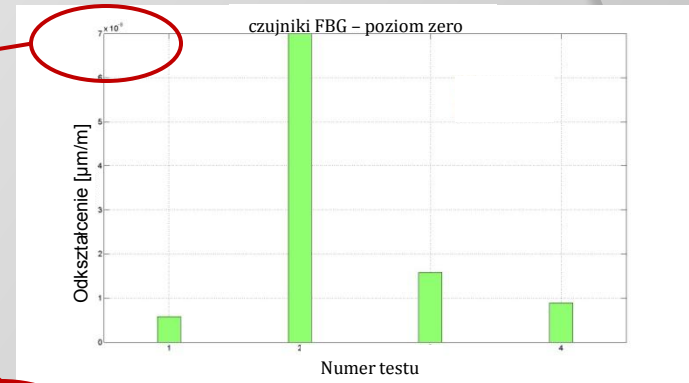

Badania dynamiczne

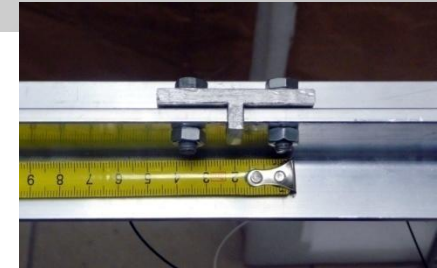
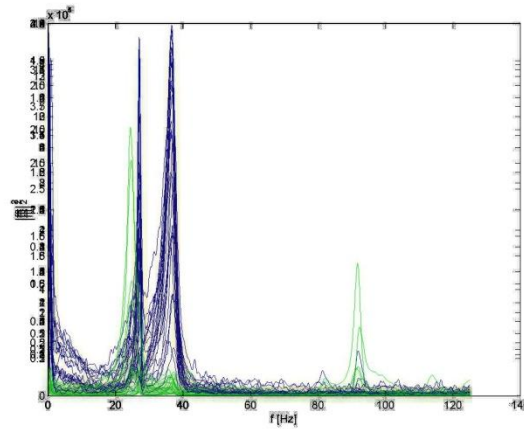
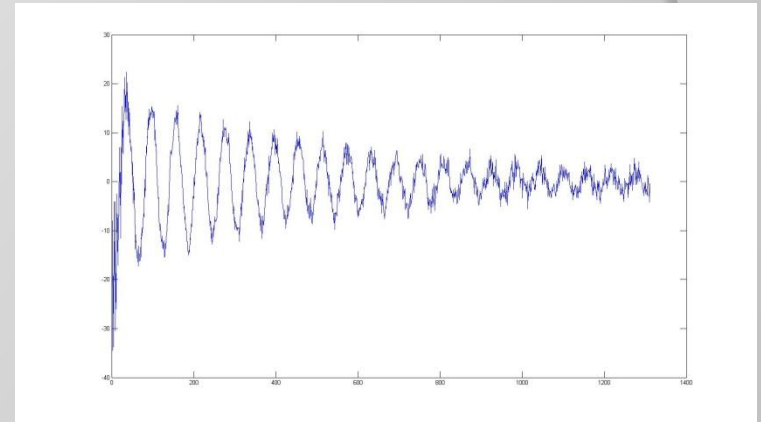
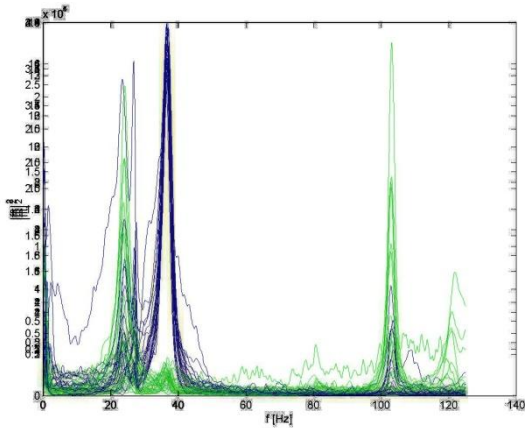
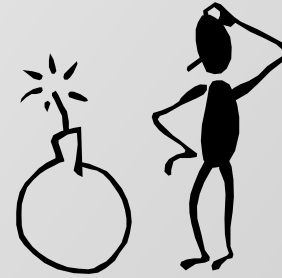
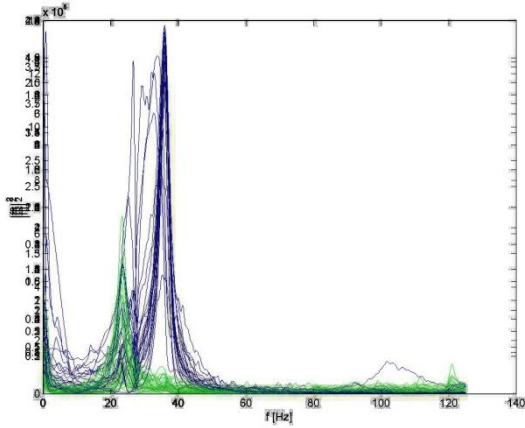

Drgania giętne i skrętne

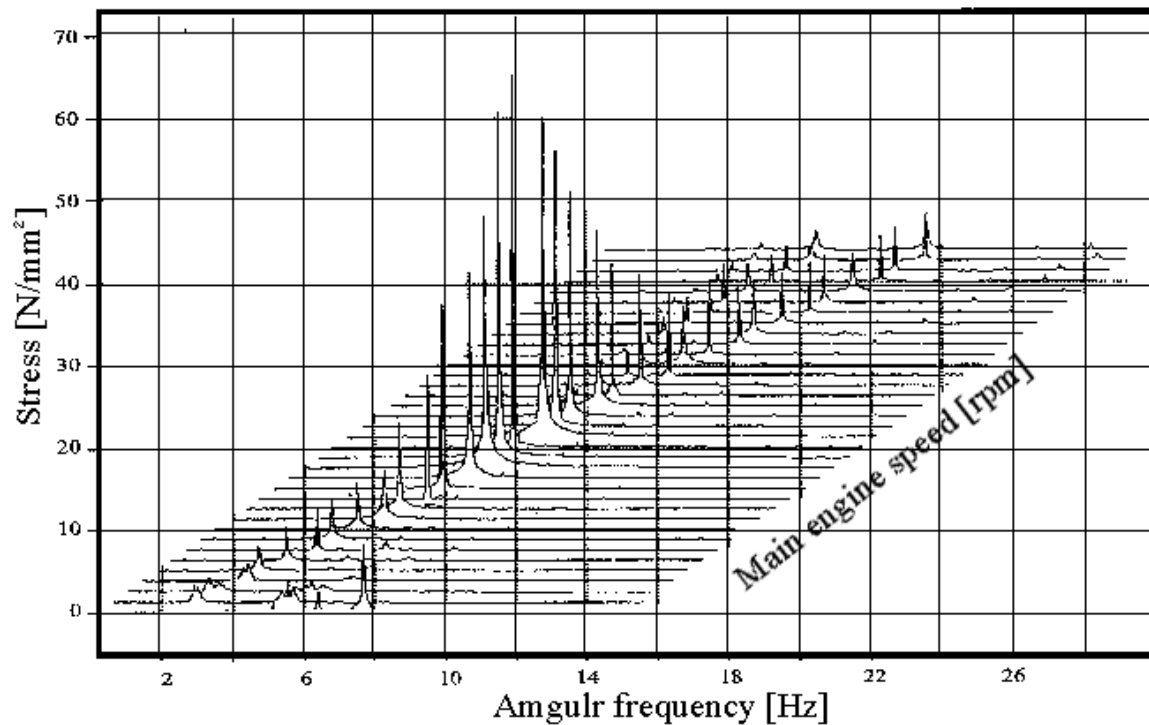
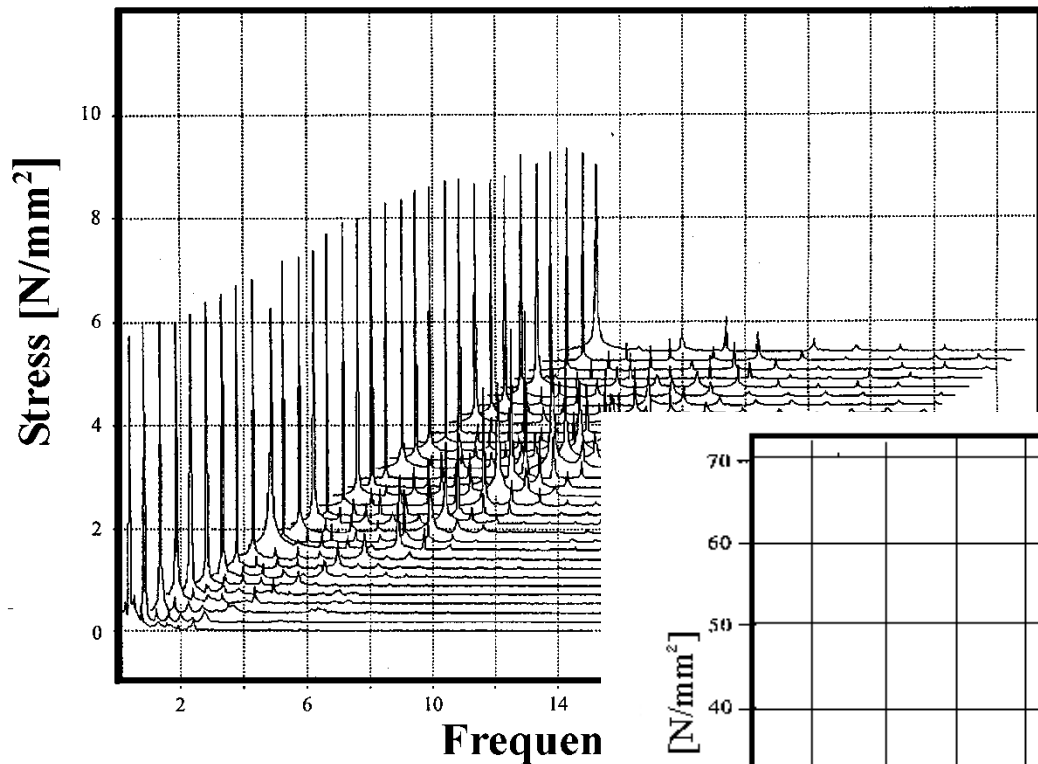

Globalne deformacje kadłuba statku w różnych stanach załadowania

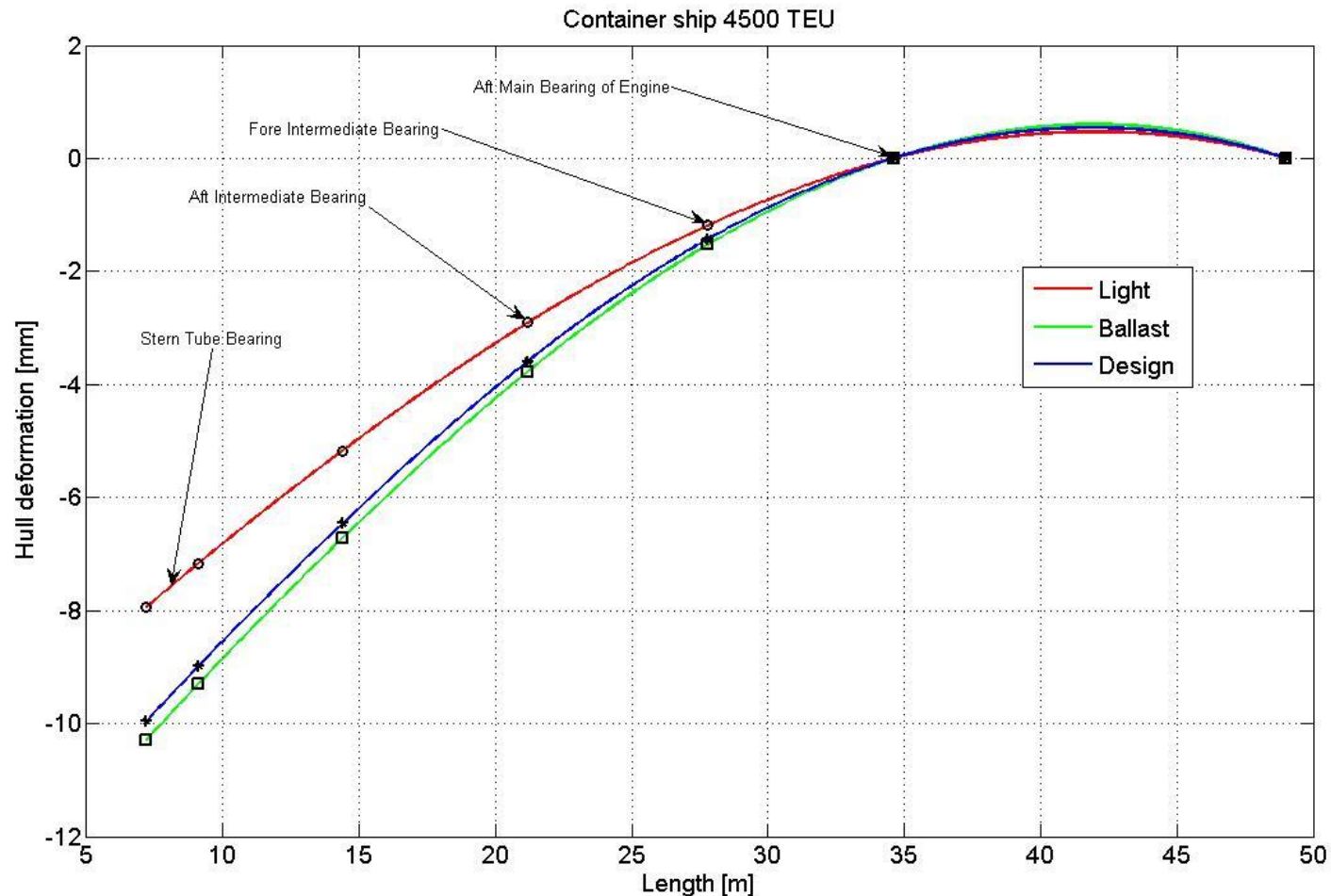

Globalne deformacije kadłuba statku na fali regularnej

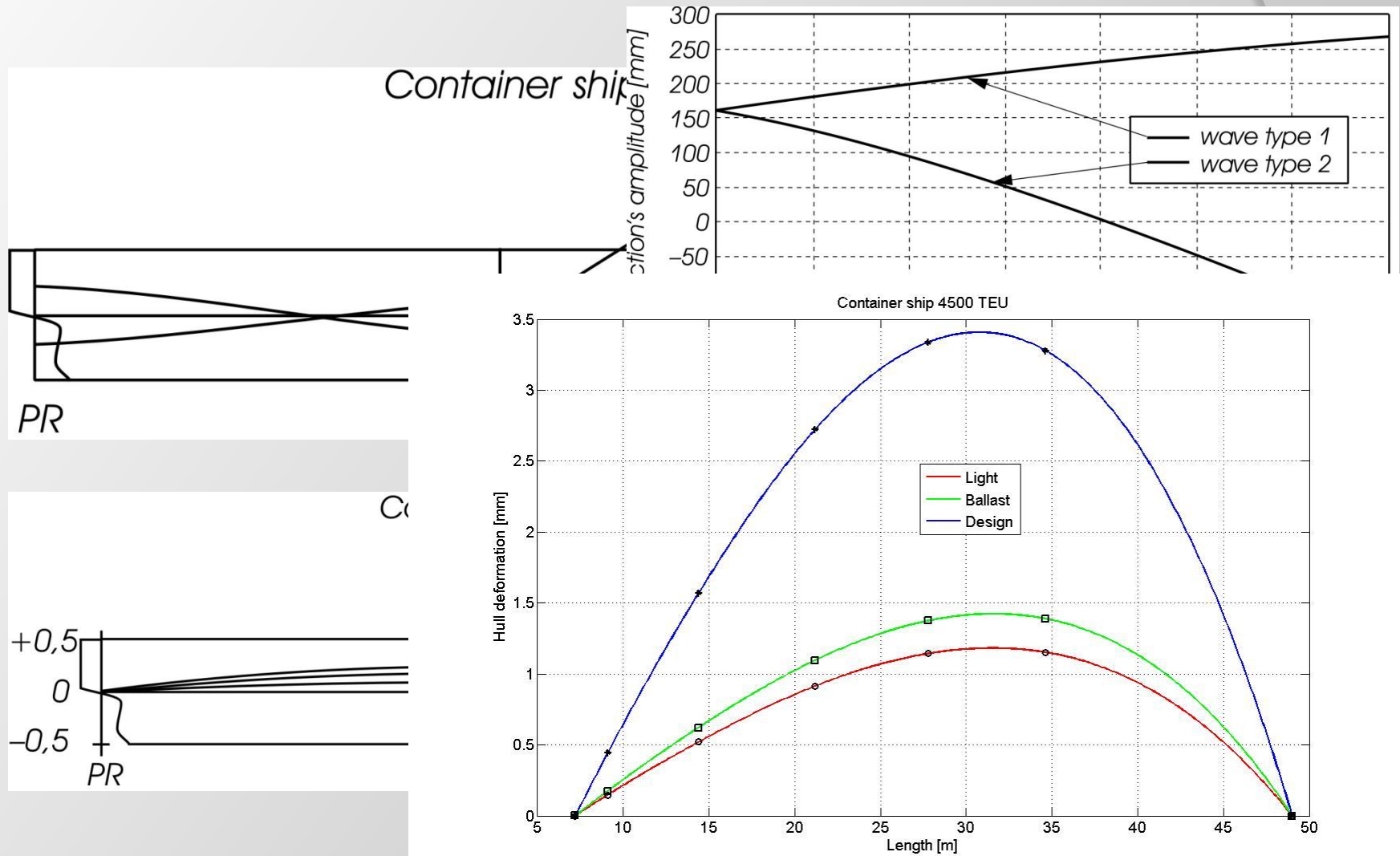

Pomiar rozkładu temperatur korpusu silnika

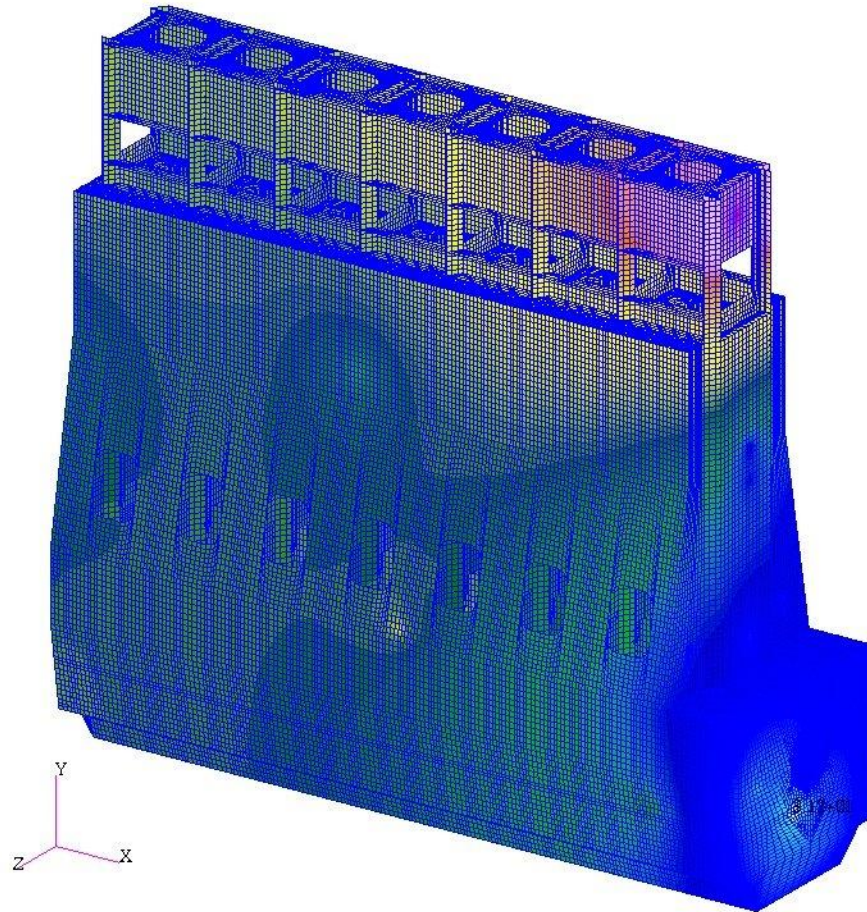
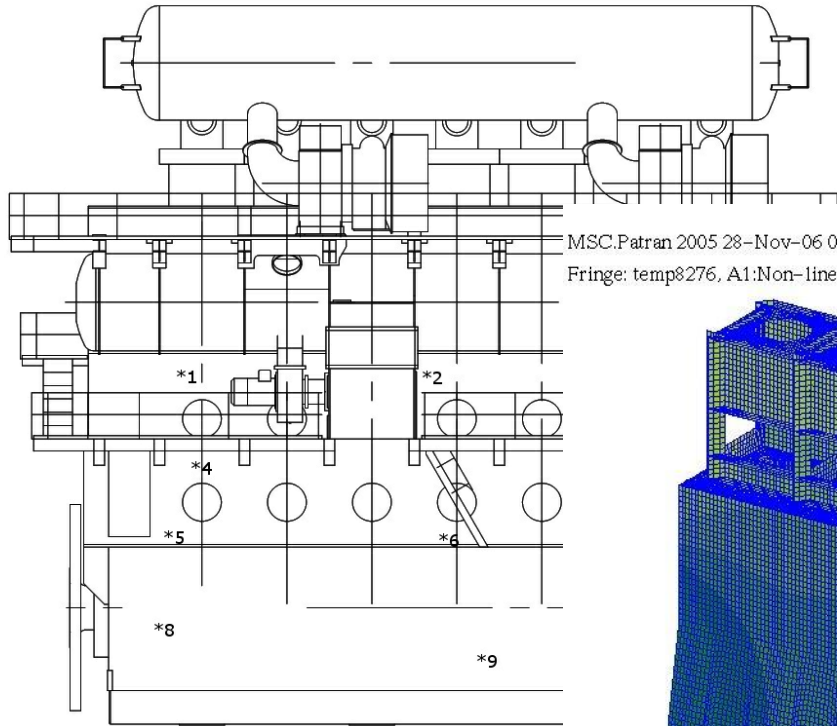

default_Fringe :
Max 6.88+01 @Nd 189921
Min 3.12+01 @Nd 313548

Termiczna deformacja korpusu silnika

MSC.Patran 2005 15-Nov-06 08:07:31

Fringe: Default, A1:Static Subcase, Displacements, Translational, Magnitude, (NON-LAYERED)

Deform: Default, A1:Static Subcase, Displacements, Translational,

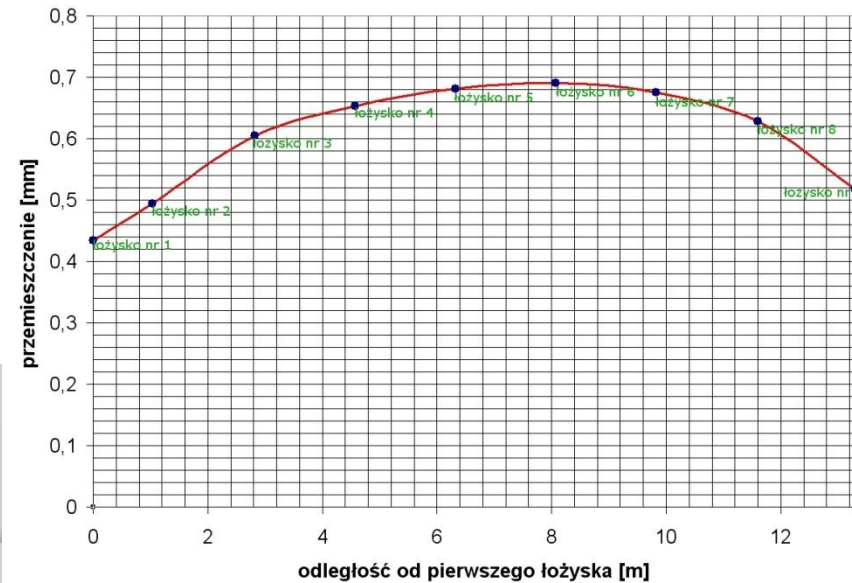
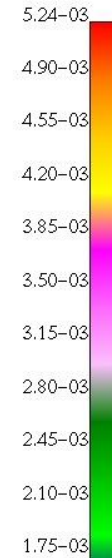
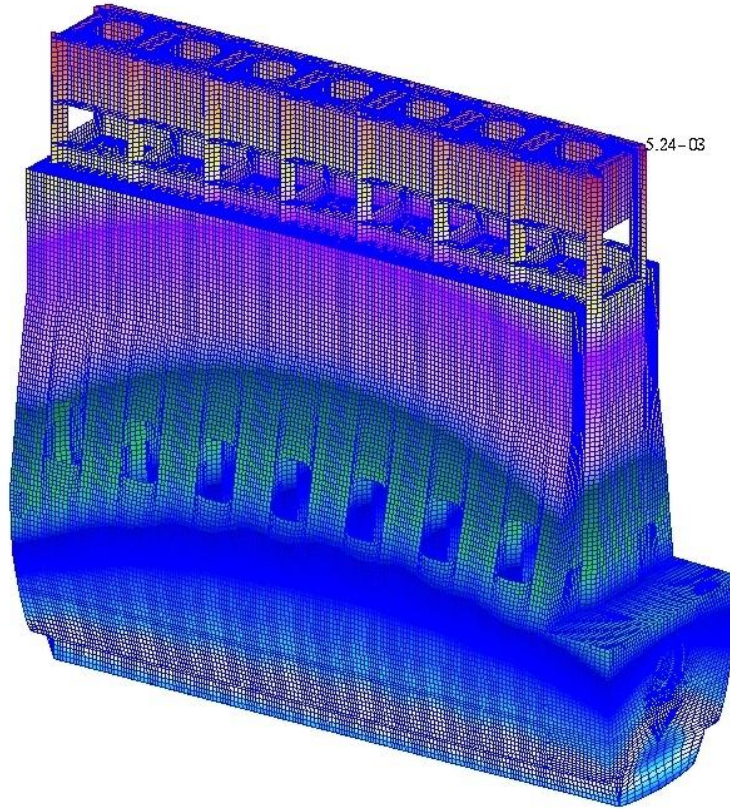

SHM Methods

There is a need for SHM methods capable of comprehensive, real-time condition monitoring

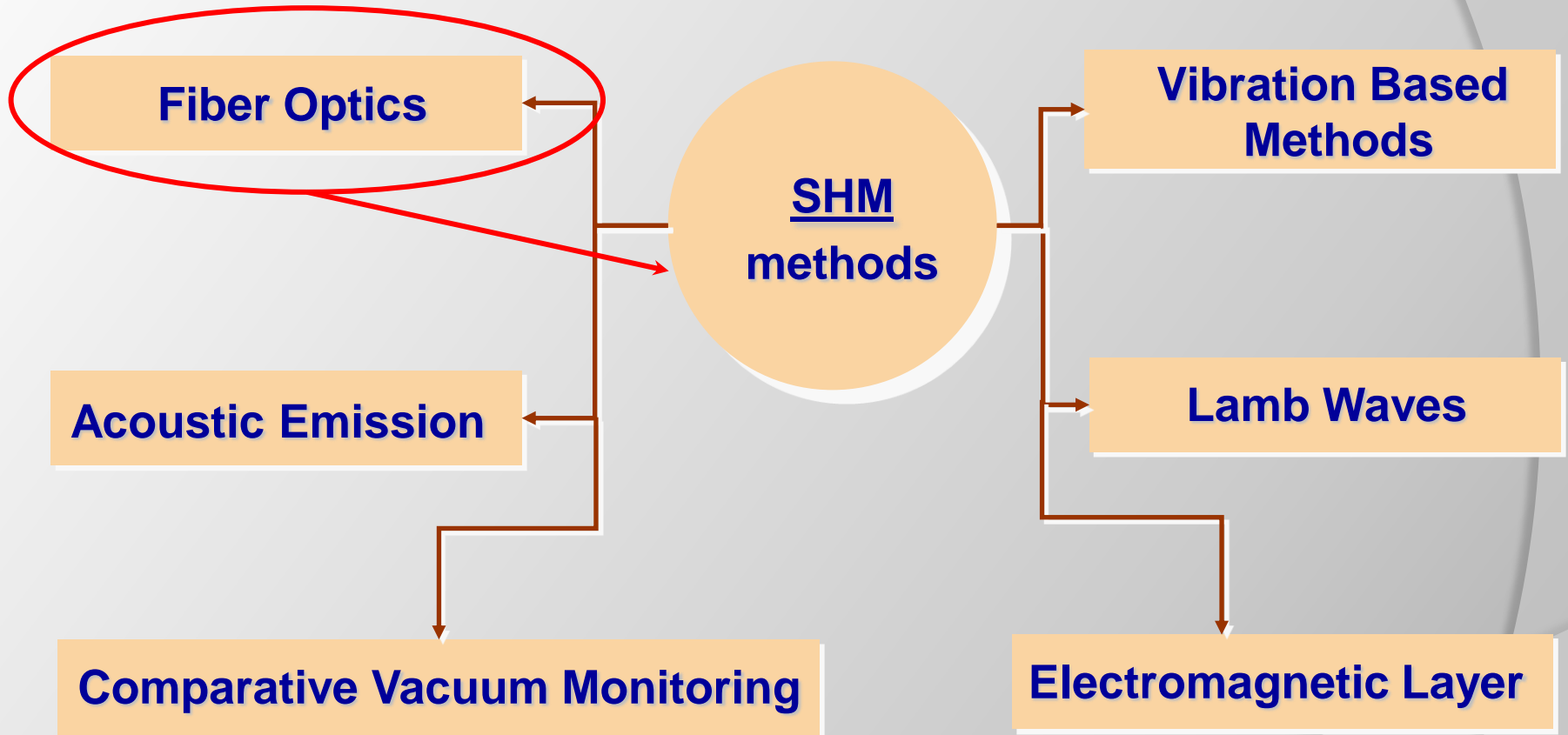

Sailing ships hazards



a

Pogoria



a₁



b

Fryderyk Chopin



b₁



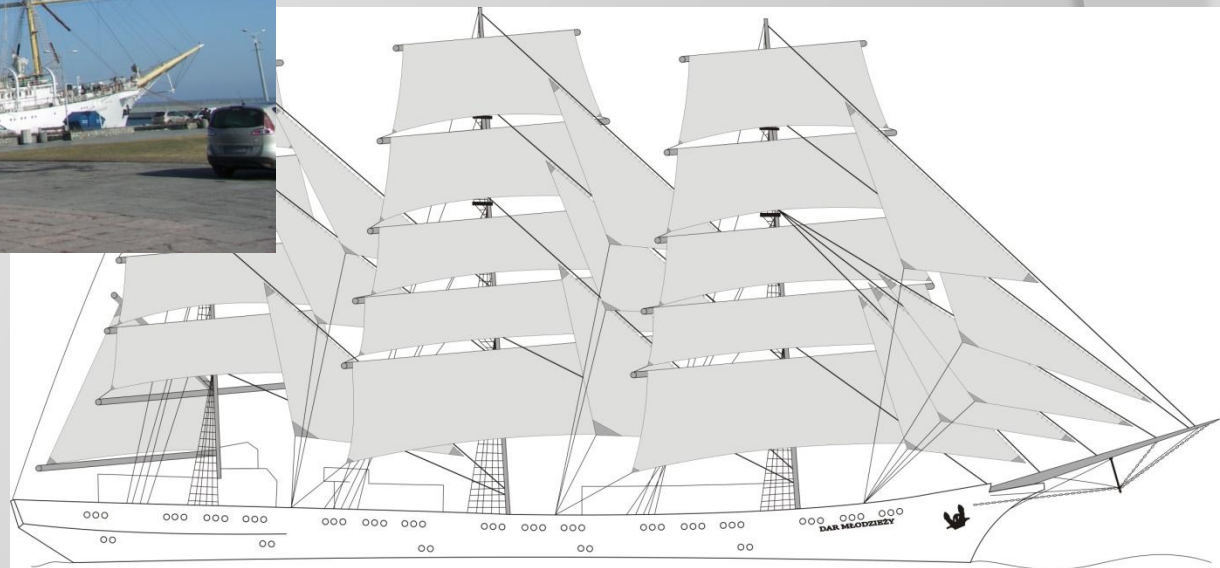

Investigated frigate: Dar Młodzieży

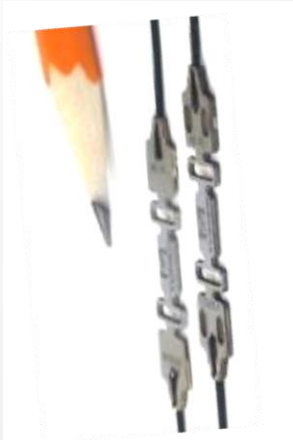

Laboratory equipment

Institute of Fluid Flow Machinery PAS, Gdansk



| | FS2500 Fiber Sensing | FS4200 Fiber Sensing | si425-500 Micron Optics | SmartScan Smart Fibres |
|----------------------|---|--|---|---|
| |  |  |  |  |
| operating range [nm] | 1530-1570 | 1510-1590 | 1520-1570 | 1528 – 1568 |
| sensor per fibre | max. 4 | max. 25 | max. 128 | max. 16 |
| optical channels | 1 | 4 | 4 | 4 |
| scan frequency [Hz] | 2 000 | 1 | 250 | 25 000 |
| dimensions [mm] | 175x105x60 | 360x275x100 | 134x432x451 | 140x110x70 |
| weight [kg] | 1.5 | 7.3 | 15.5 | 0.9 |

Experimental investigations of the foremast

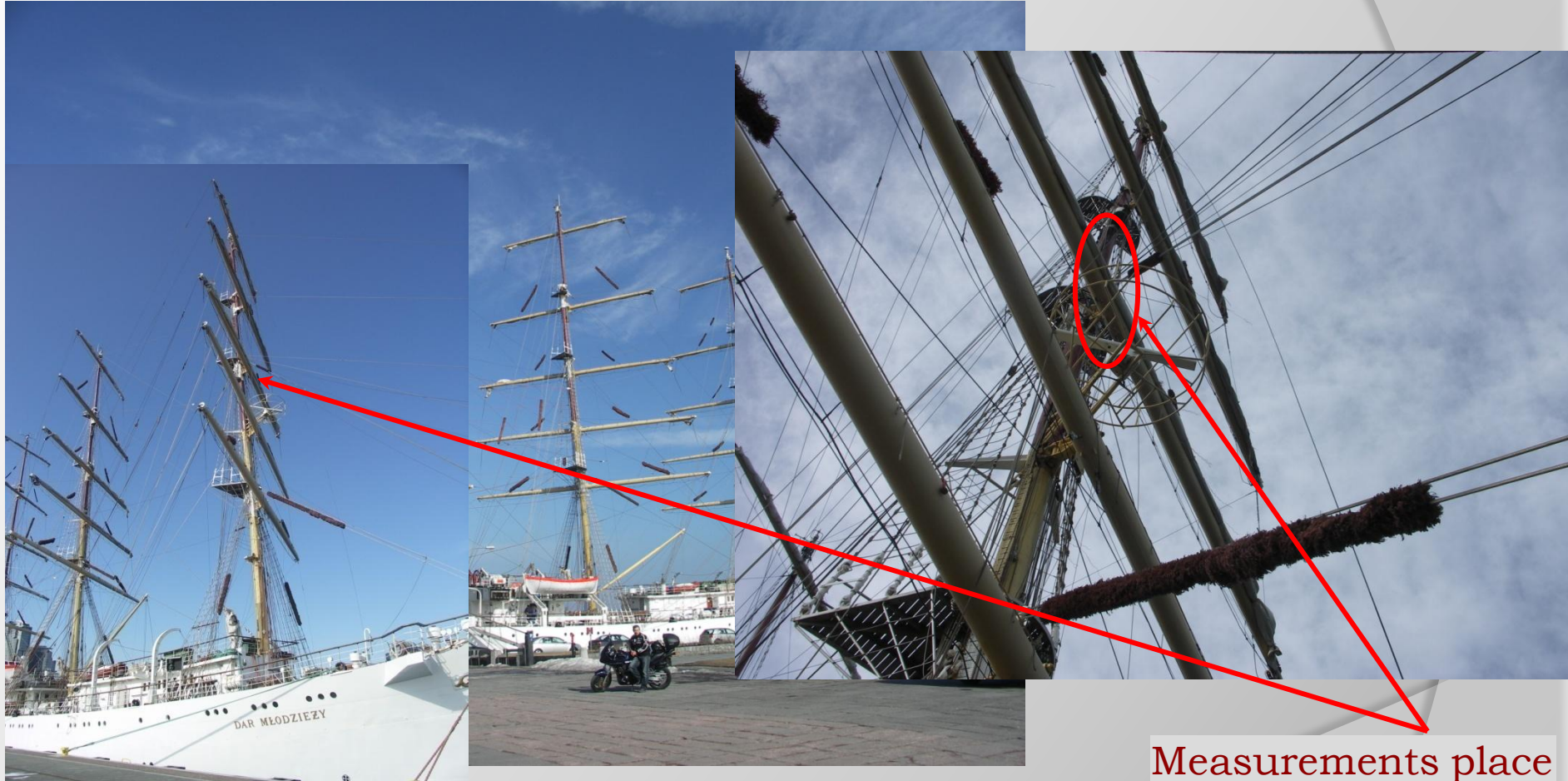

Measurements place

Experimental investigations: three stays from foremast to bowsprit

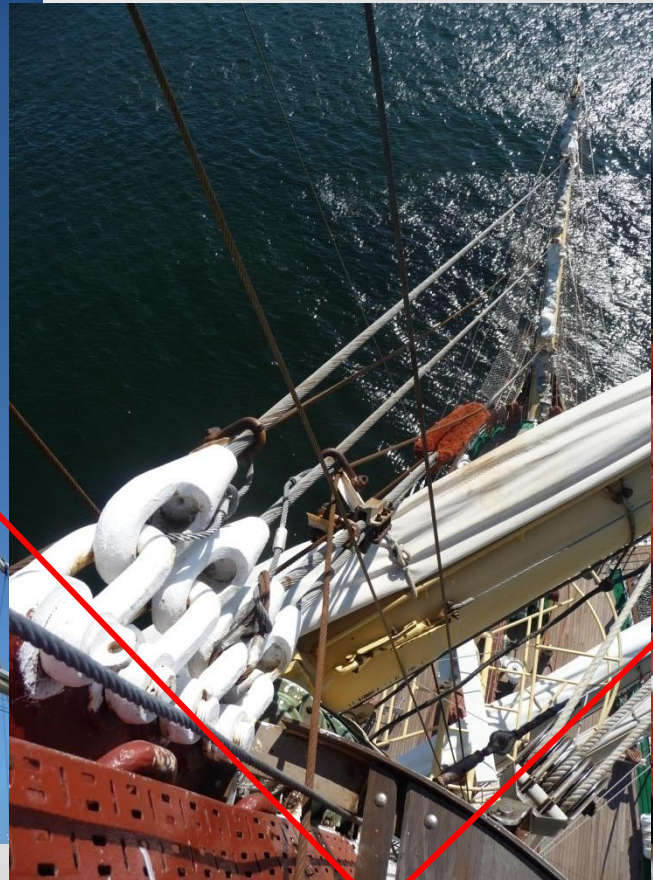

Measurements area

Experimental investigations: equipment

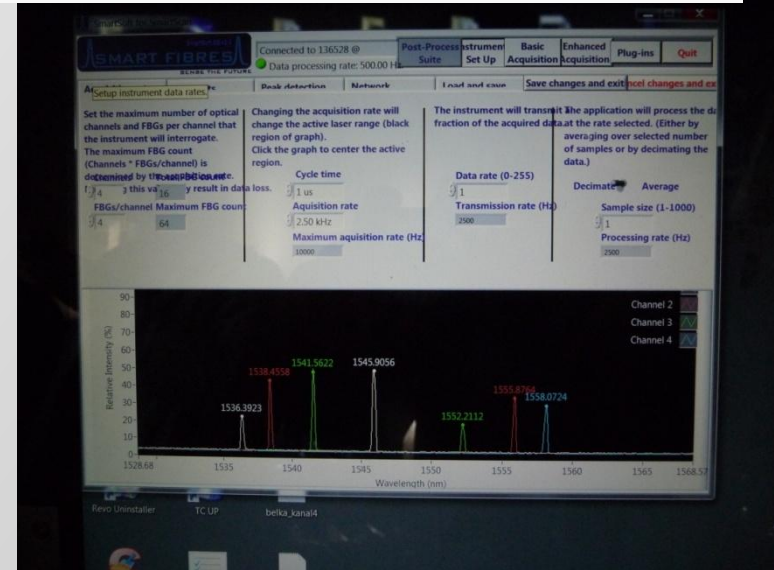
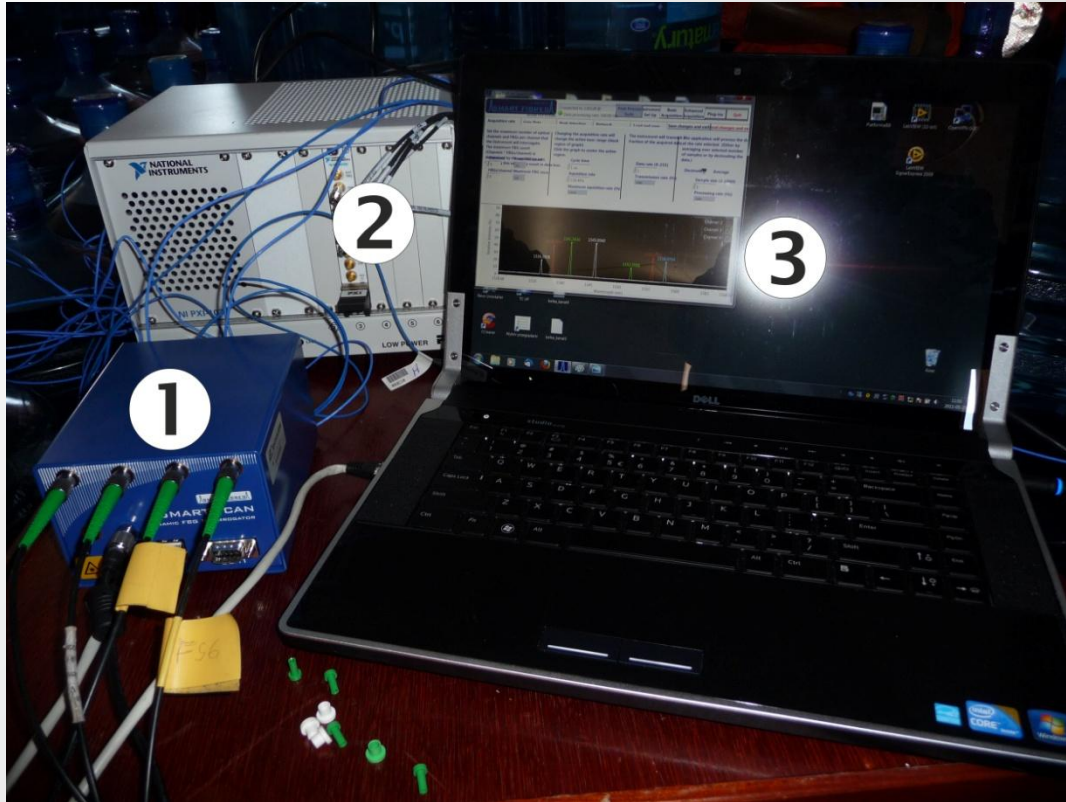

Experimental investigations: FBG sensor on the foremast

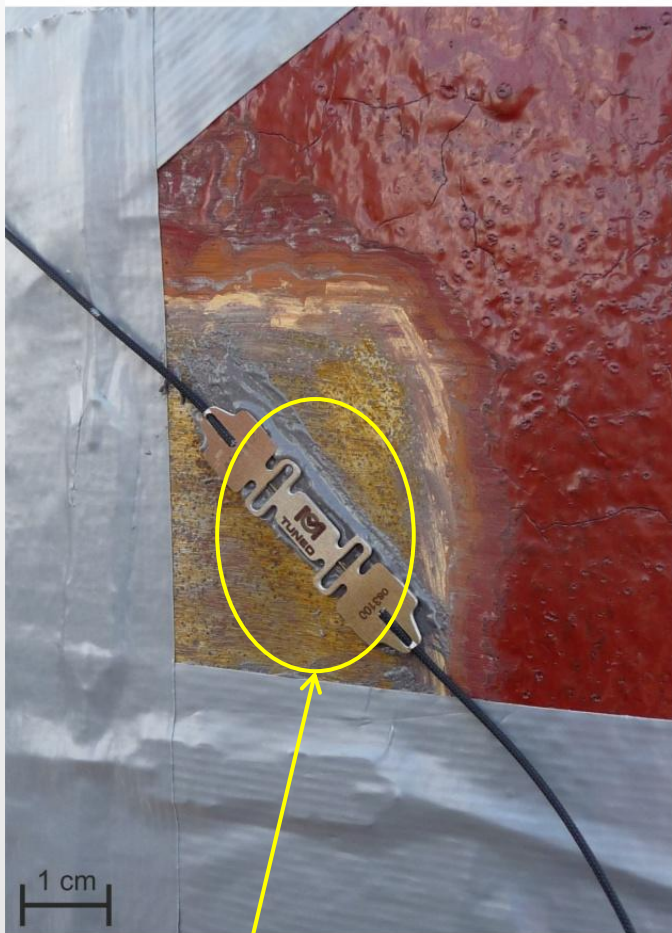

FBG strain sensor



b)

Experimental investigations: FBG sensors location

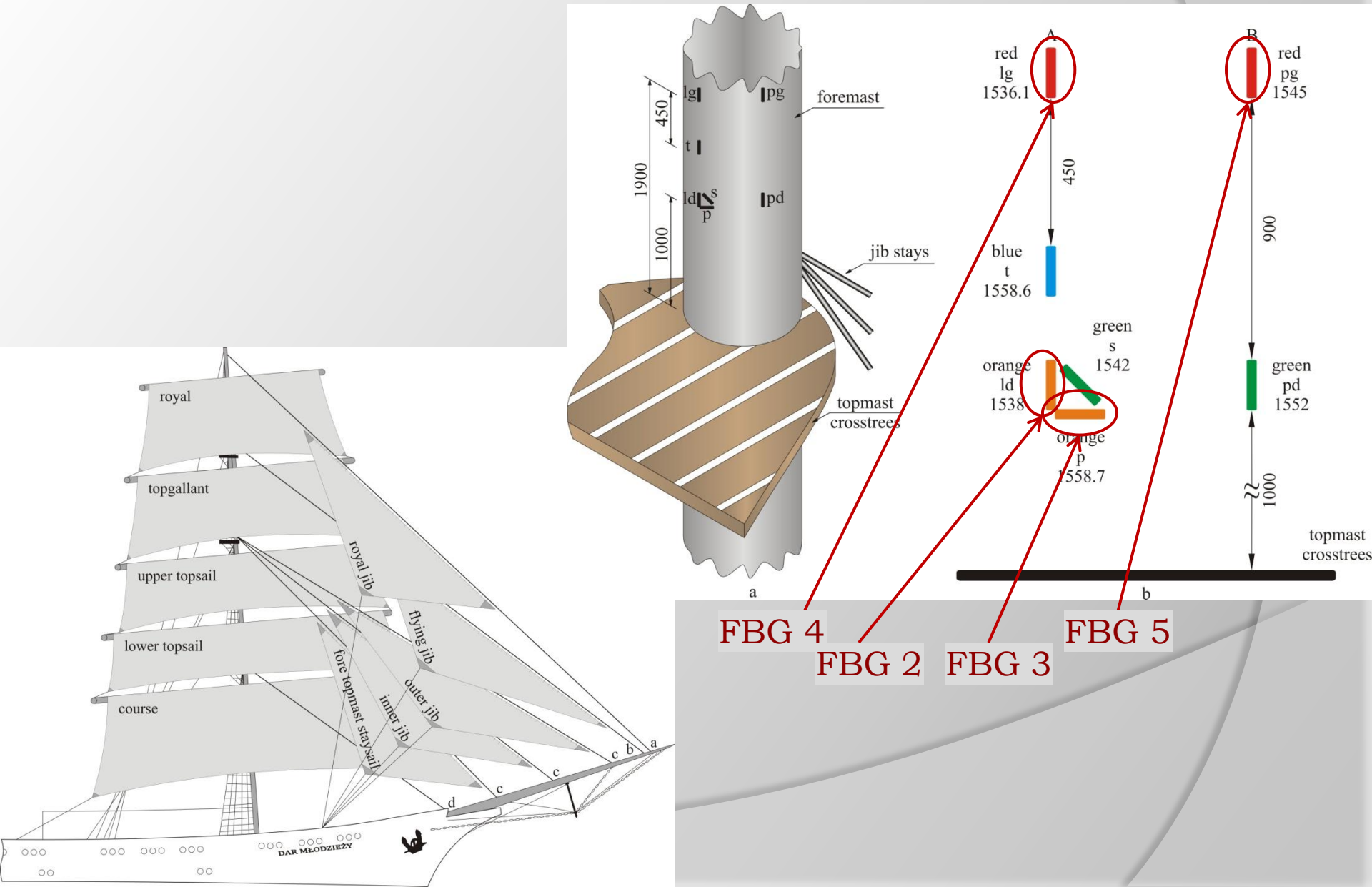

Route of the Dar Młodzieży

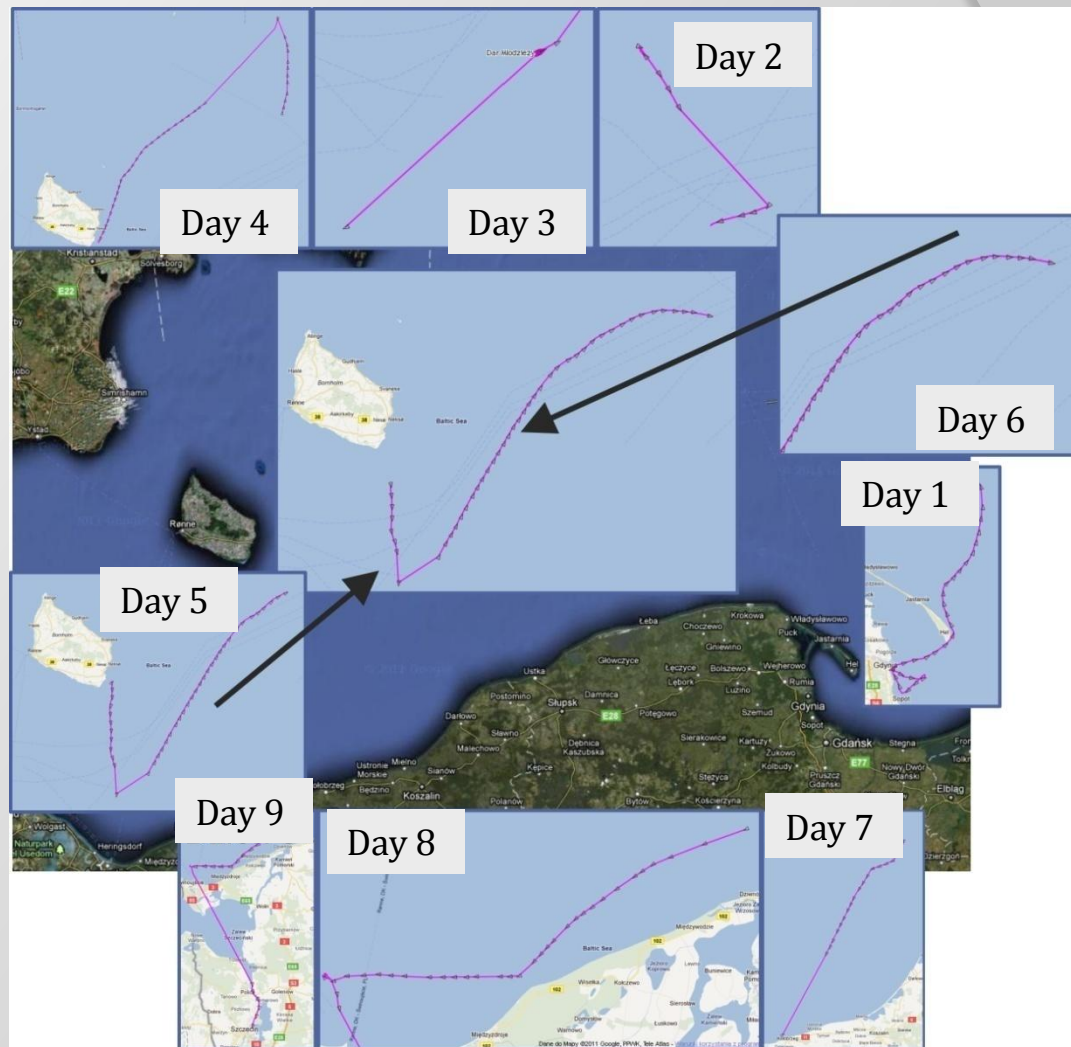

Hull vibrations and displacements

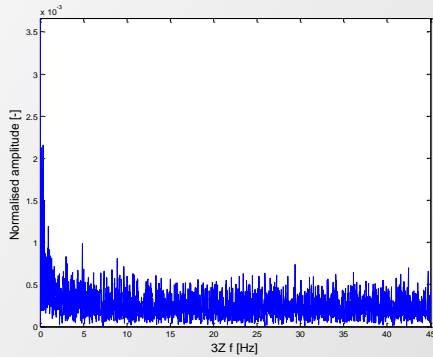

Classical PZT accelerometers

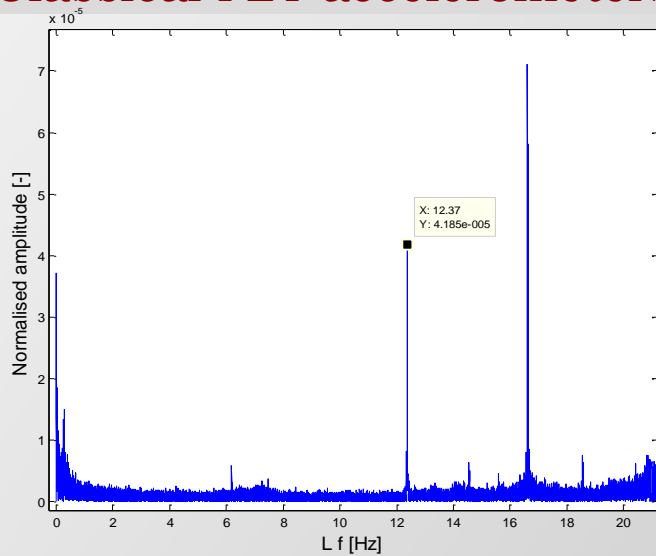

Seismic PZT accelerometers:
equipment vibrations

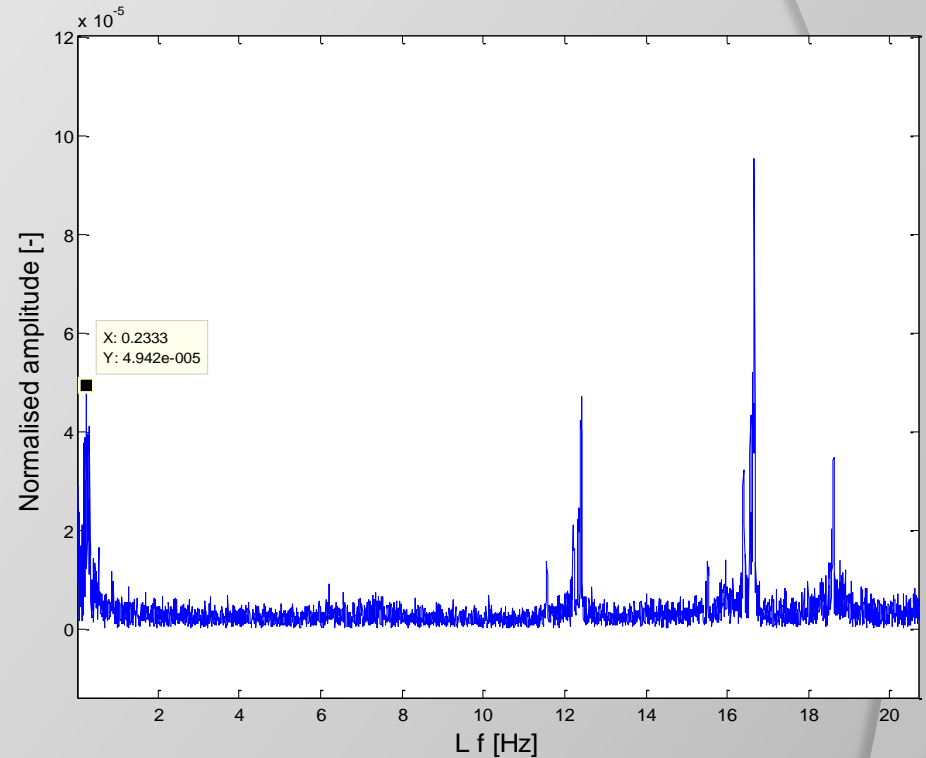

Seismic PZT accelerometers:
ship rocking

FBG sensors data – sails settings

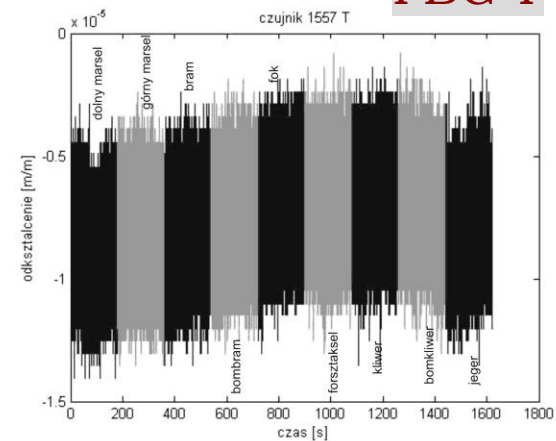
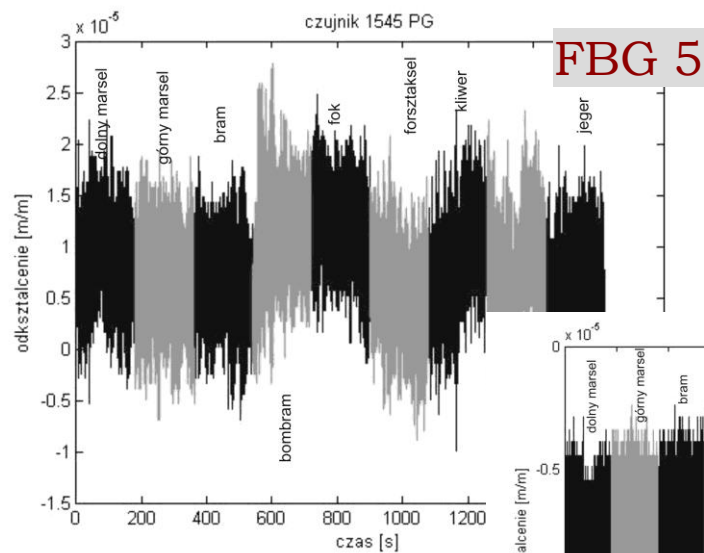
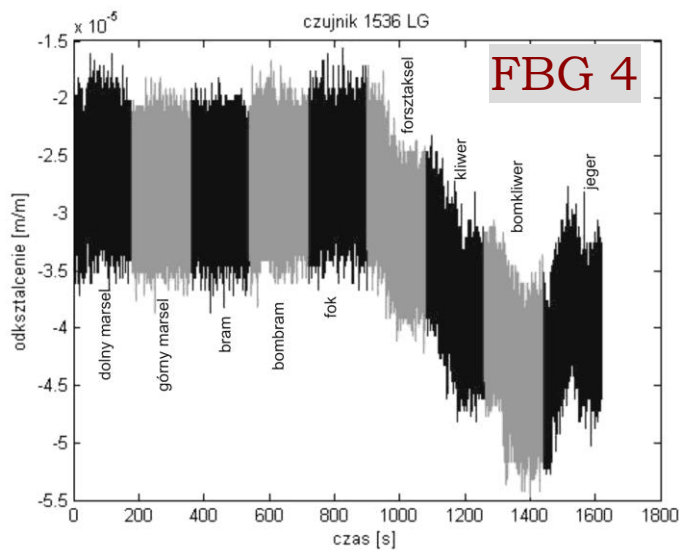
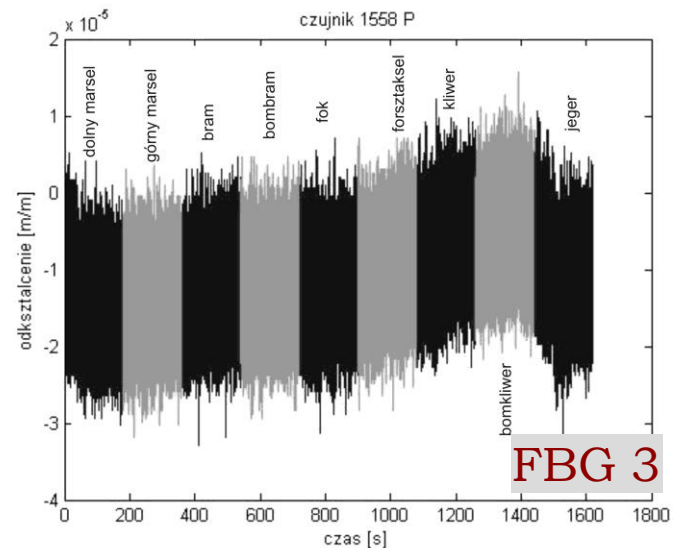
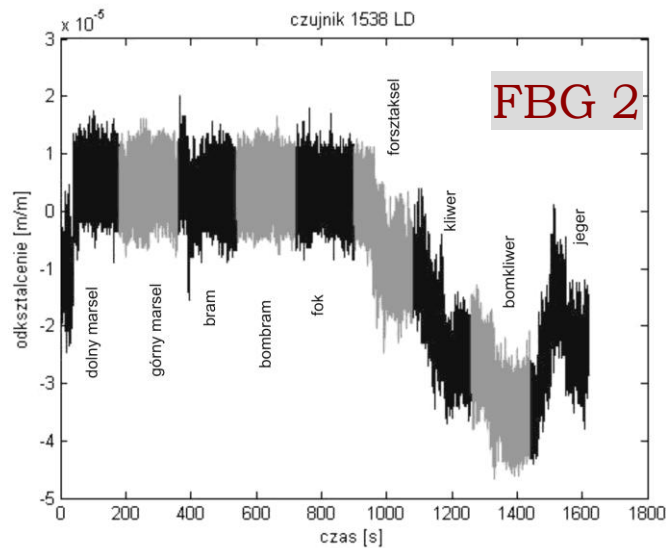

Zero deviation in the port

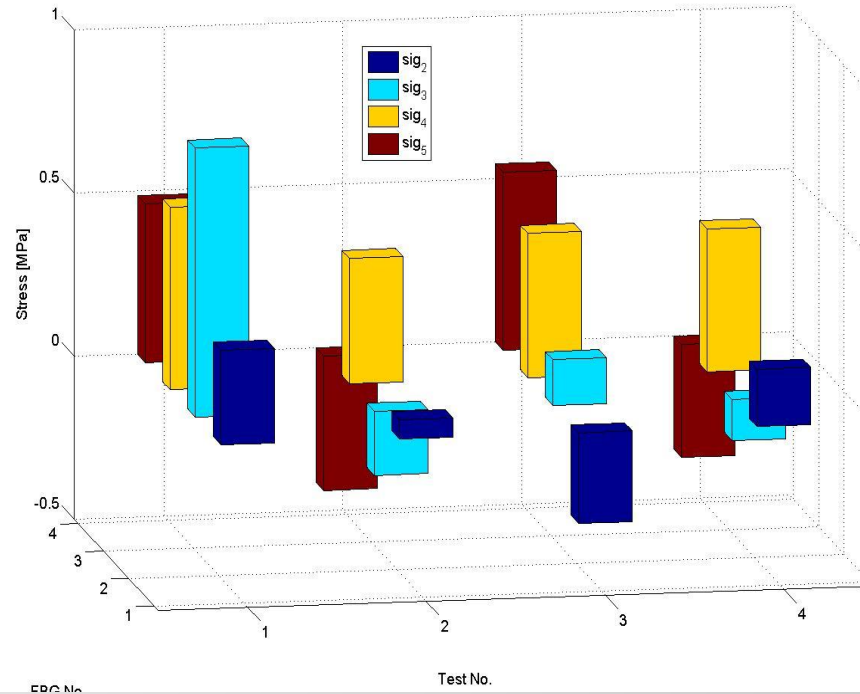

- four day measurements in different time of day
- temperature compensation
- fluctuations source: mostly, changes of rigging temperature

Sails setting – close to Gdynia harbour

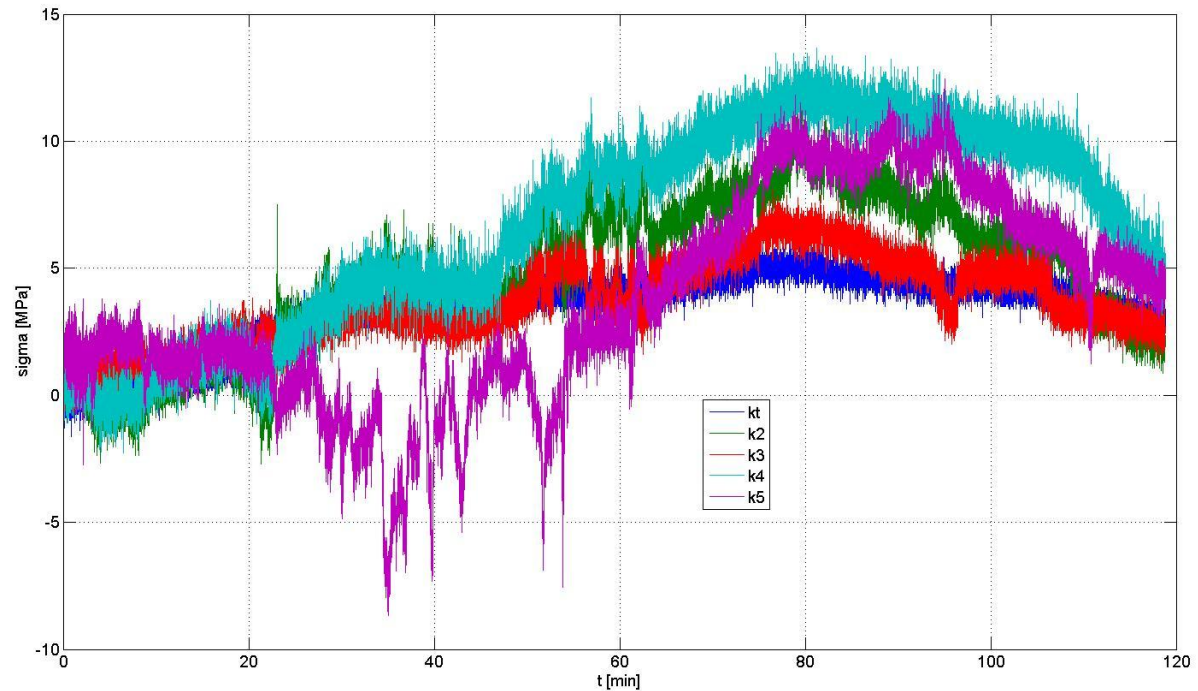
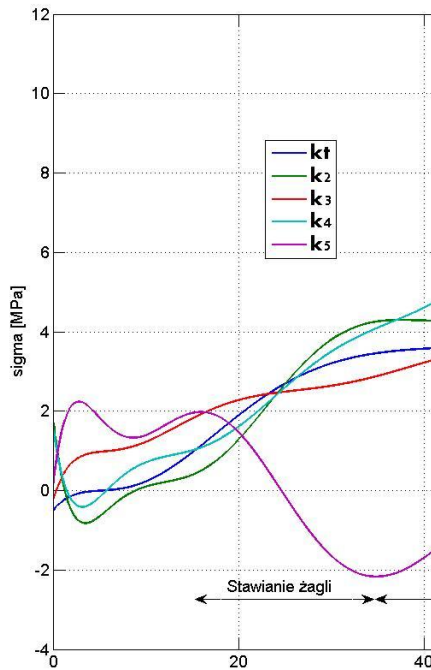

- quasi-static stress changes in the foremast during maneuvers are close to 12 Mpa
- high-frequency stress deviation, (~2 Mpa), -> comes from FBG sensors characteristics
- stress peak (~5 Mpa – FBG No. 5), -> comes from eksploitations: maneuvers, sails setting

Steady sailing conditions

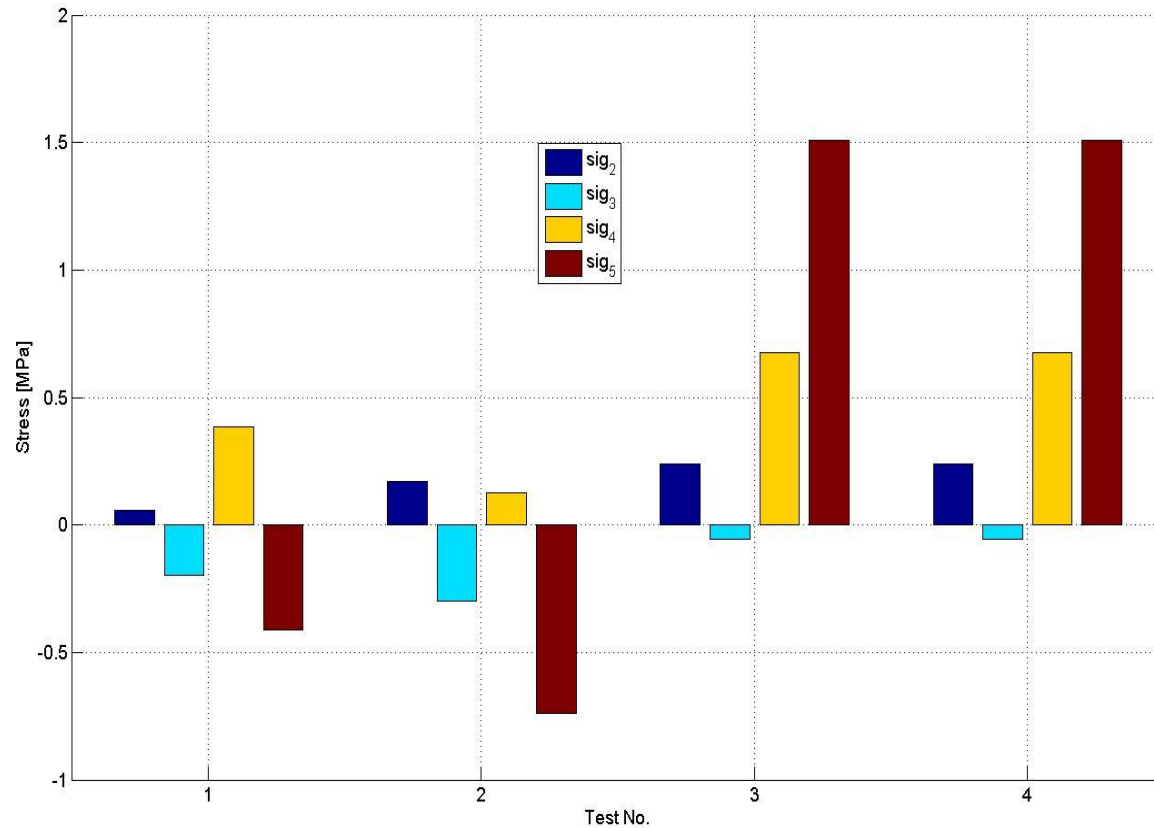

- Test No.1 without sails; Test No.2 full sails, wind 6 knots
Test No.3 i 4 sails: course and both topsail, wind 15 knots
- stability and repeatability of SHM system is very good

Steady sailing conditions - dynamic

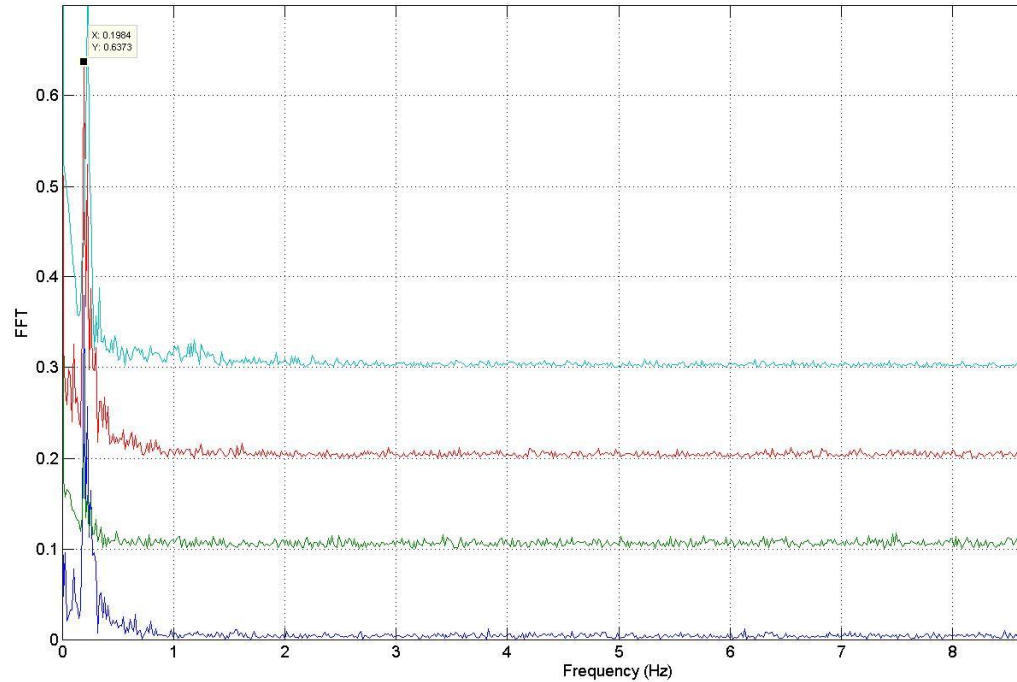
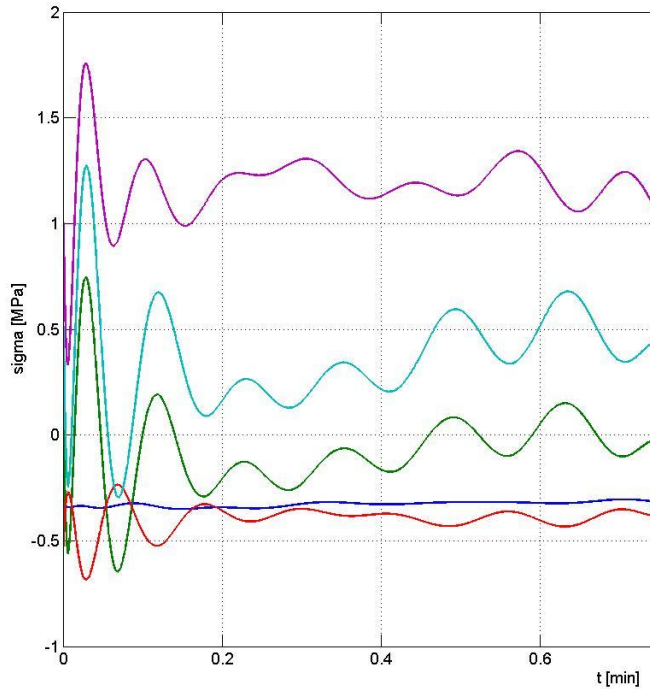

- Excitation oscillations of the foremast; sails: course and both topsail, wind 15 knots
- All FBG sensors shows the same characteristic = ~ 0.2 Hz. Period of change is equal to sea waves period; accelerometers shows the same value
- Taking into account fatigue strength might be important

Sails settings I

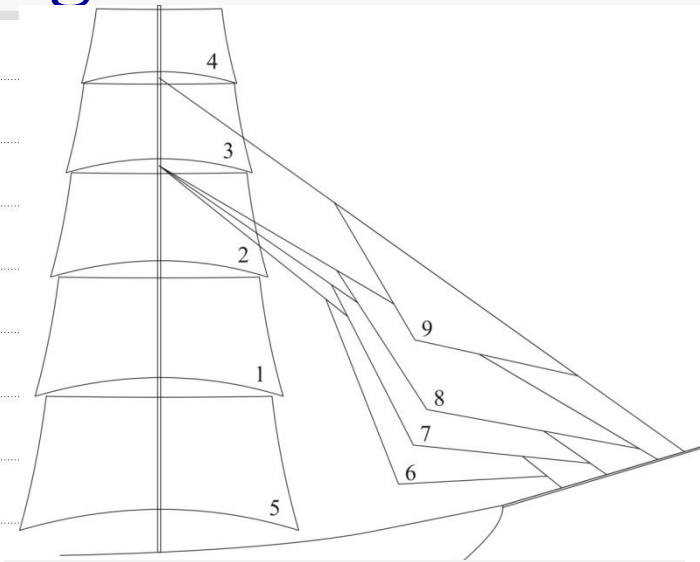
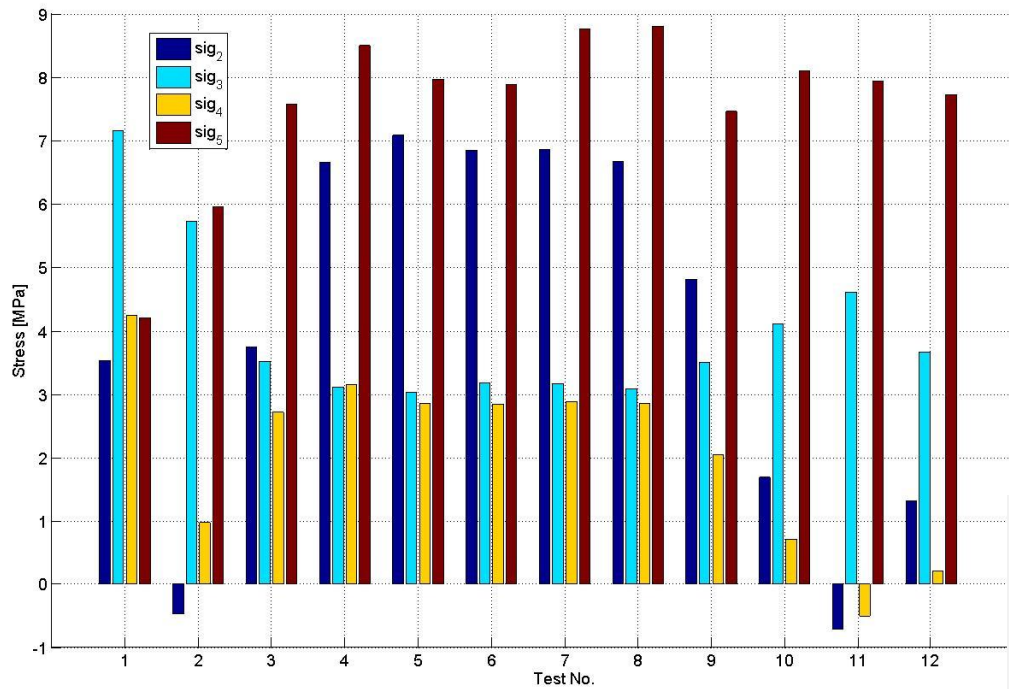

1- Tack by the stern, 2 – jibs removal,
 3 – without sails, 4 – lower topsail setting,
 5 – upper topsail setting, 6 – topgallant setting,
 7 – royal setting, 8 – course setting,
 9 – staysail setting, 10 – inner jib setting,
 11 – outer jib setting, 12 – flying jib setting

- Test No.12: close hauled, tilt up to 7°; sea 2°B; wind 15-20 kt.,
- Transverse stresses (sig₅) of the mast are depended on the sailing conditions
- Stresses in the ship P.S. (sig₂, sig₄) are depended on the number of sails
- Jib settings is a source of offloading of the top part of the foremast

Sails settings I - dynamic

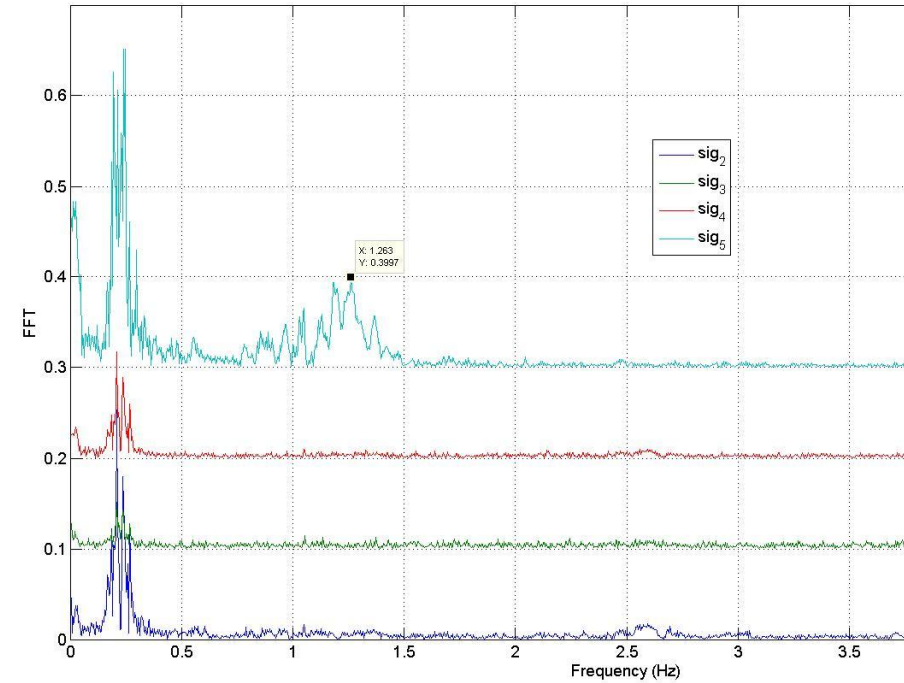
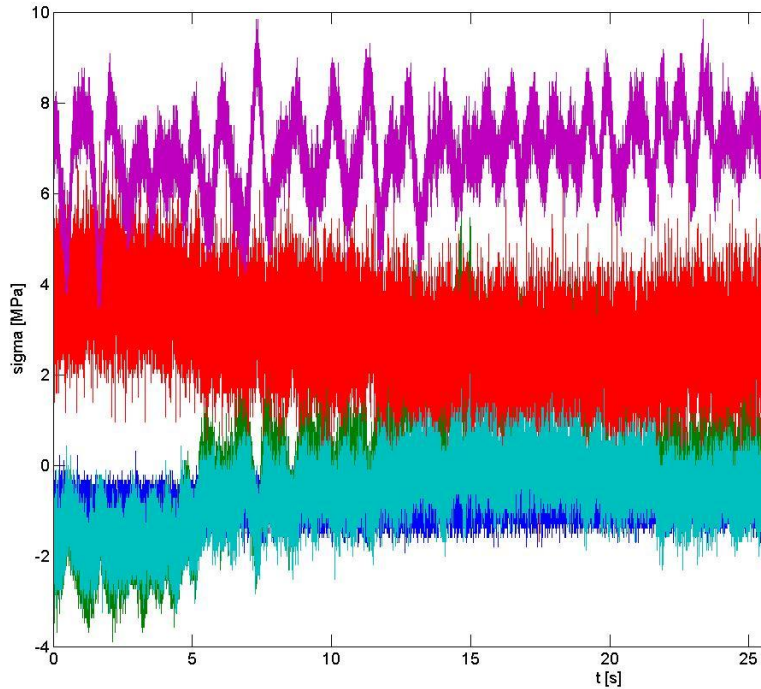

- Test No. 7: full sails of the foremast without jibs and course
- FFT -> waves loading -> $T \sim 6.5$ sek. + natural vibrations of the foremast -> $f = 1.26$ Hz
- Foremast without jib loading is sensitive on the dynamic excitations
- Foremast loaded by jib sails is more stable, is less sensitive even on wave loadings

Sails settings II

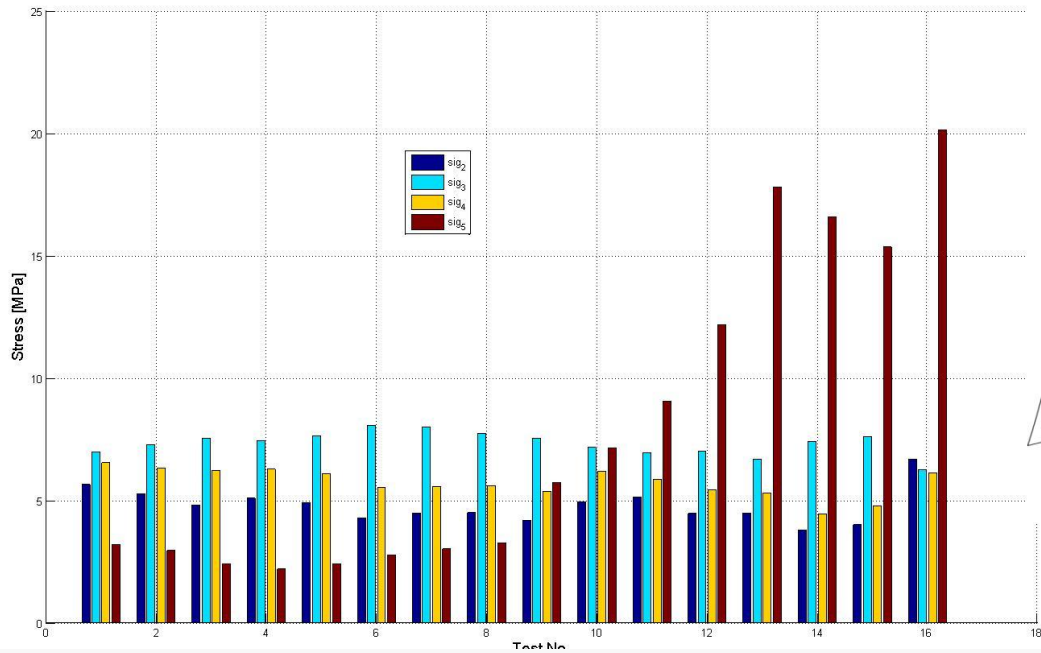

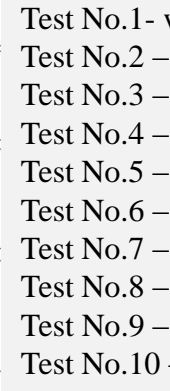
- 
- Test No.1- without sails
 - Test No.2 – staysail setting
 - Test No.3 – inner jib setting
 - Test No.4 – outer jib setting
 - Test No.5 – flying jib setting
 - Test No.6 – lower topsail setting
 - Test No.7 – upper topsail setting
 - Test No.8 – topgallant setting
 - Test No.9 – royal setting
 - Test No.10 – course setting
 - Test No.11 – royal removal
 - Test No.12 – course removal
 - Test No.13 – tack by the stern
 - Test No.14 – course setting
 - Test No.15 – sails brace
 - Test No.16 – steady sailing

- Test No.16: close reach, speed up to 9 kt.; sea 3°B; wind 17 kt.,
- Ship tack or sails brace is source of bigger transverse stresses than sail settings
- Relative wind changing caused transverse stresses level increasing (2x) with relative small stresses level changing in the ship P.S.
- Isolated course removal (test No.12) is a source of important transverse stresses level increasing
- If the loading of the mast is heavy then vibrations and fatigue stress of the mast is negligible

Different exploitation conditions

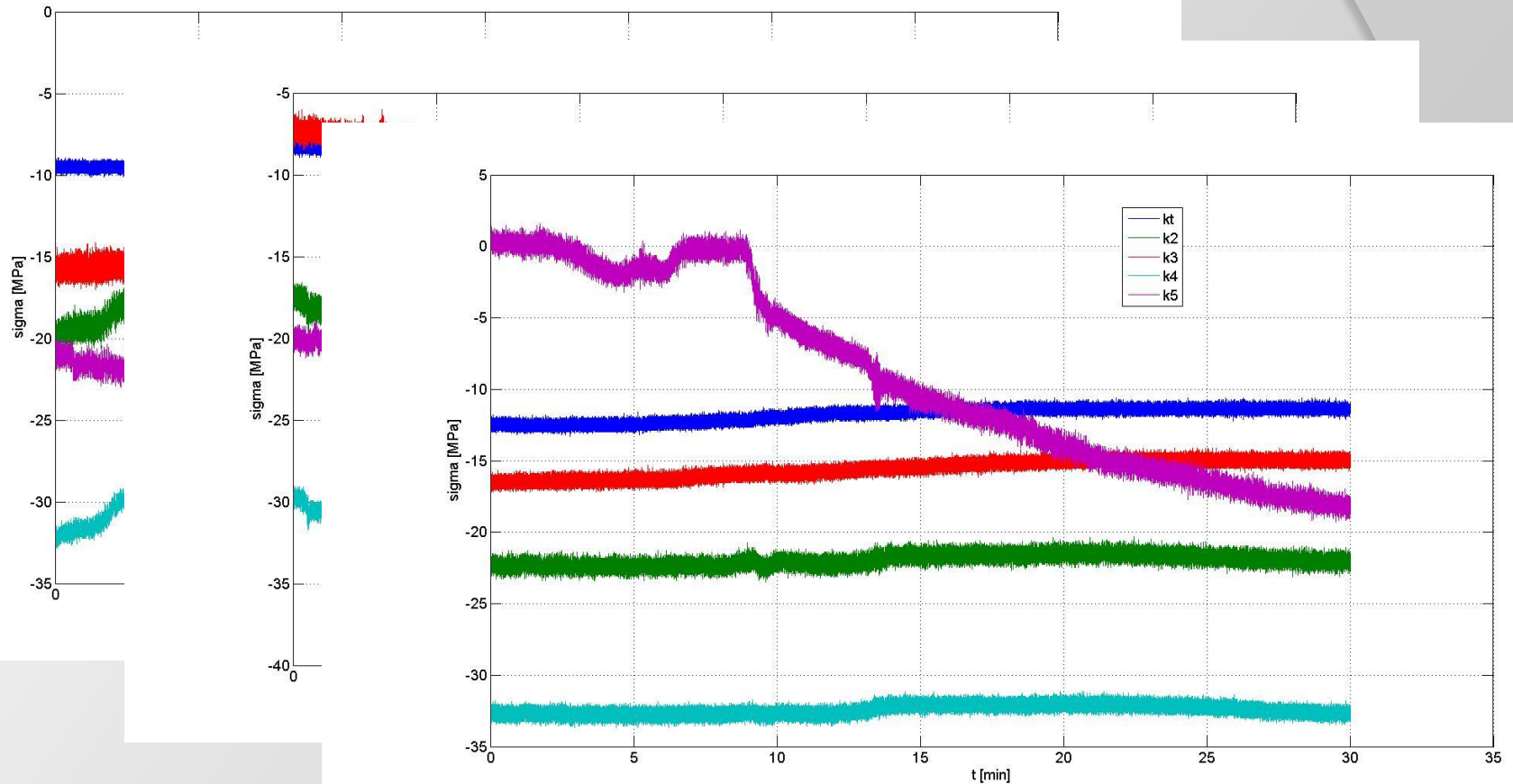

- Test No.1: speed 2.8 kt.; sea 2°B; wind 12-17 kt., topsails+jibs, still tack
- Test No.2: speed 9.6 kt.; sea 3°B; wind 18 kt., settings and removing sails
- Test No.3: speed 3.5-4.8 kt.; sea 2°B; wind 10 kt., adding the sails

Sails settings and remouving

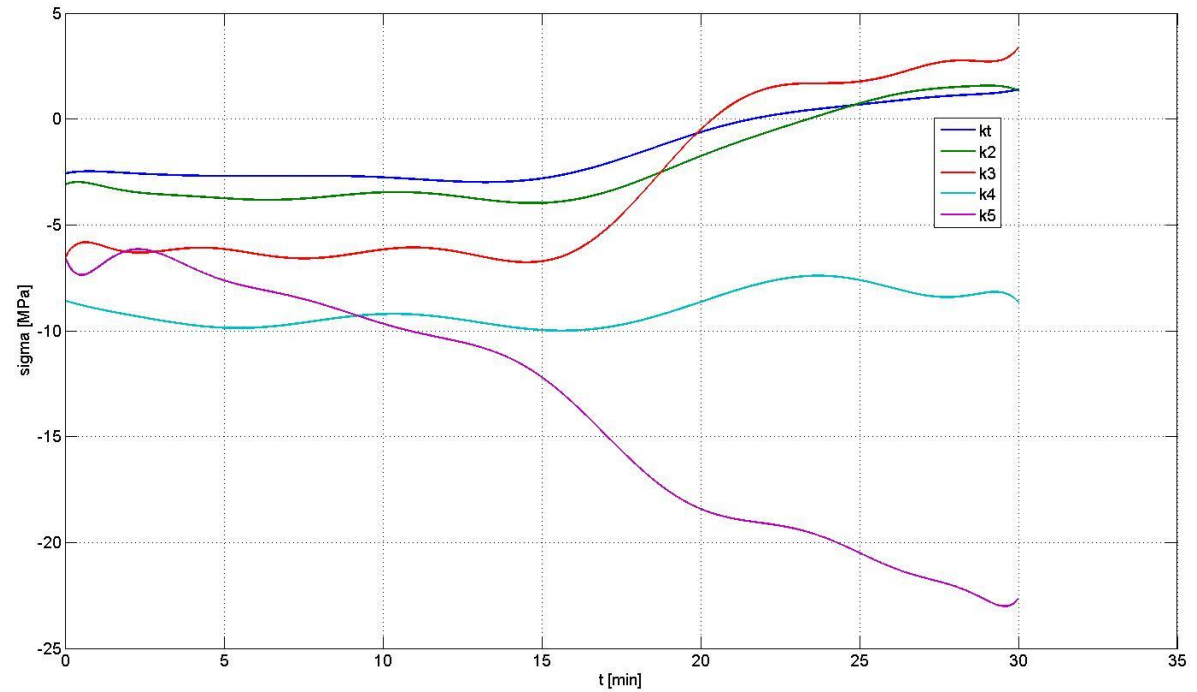
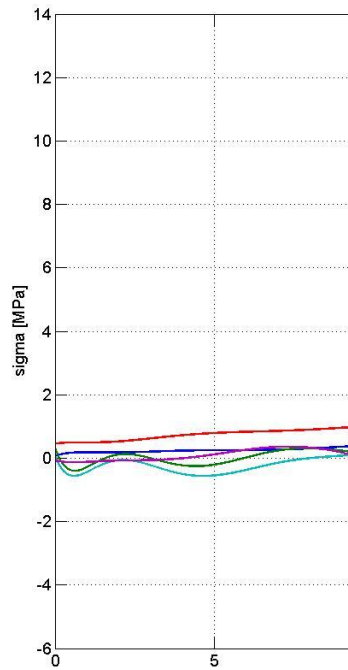

- Test No.4: 1°B, wind 6kt, speed max 2.6 kt, sails setting from anchor;
- Test No.5: 3-4°B, wind 26kt, sails remouving (from topsails) and anchoring;
- Influence of upper topsail remouving (10 min) for stress level is negible, all sails remouving (16 min) was a source of stress distribution changing
- Anchoring was performed at 21 min

Stability and reliability of the SHM system

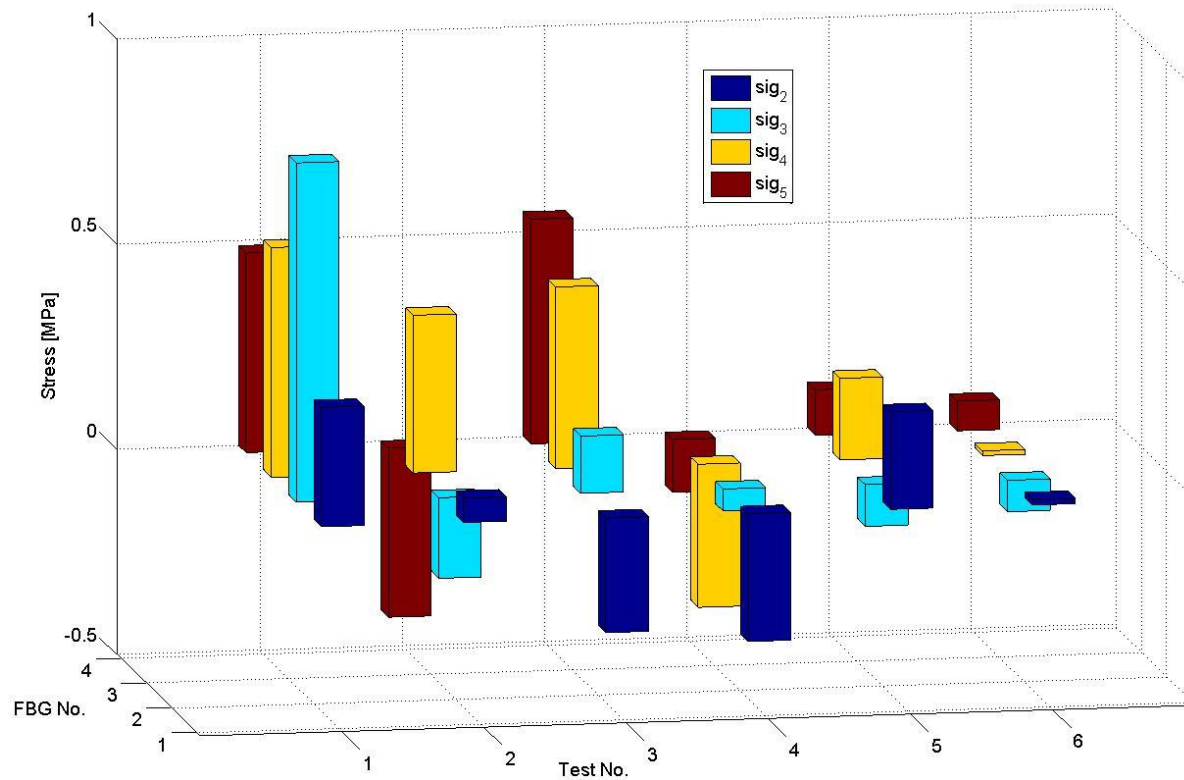

- Stresses reference level („zero”) recorded at 25, 29, 31 may, 5 june and 23 september 2011
- Differences are less then 1 MPa -> good result because of long time and different environmental and eksploitation conditions

Dziękuję za uwagę!

